

Attachment 11.1.2

Shire of Nannup
15 Adam St
Nannup 6275

SHIRE OF NANNUP RECEIVED	
Ref: <u>B1451</u>	No: _____
16 AUG 2023	
Officer: <u>Jane</u>	

16 August 2023

To Whom it May Concern,

Re: Application For Development Approval

I am writing to you to submit an application for development approval for the property located at 314 Chalwell Rd, Carlotta. It is my intention to use the dwelling as a holiday rental once the application has been approved.

Please find attached the documents requested as part of the application process. I have been in communication with Louise Stokes at Bushfire Prone Planning to assist in developing a Bushfire Emergency Plan and to ensure that all measures have been taken to mitigate the fire risks associated with the location of the property.

The property is a 4 bedroom house and comfortably sleeps 8 guests. Pets will not be permitted under the guest booking conditions and it is our intention to engage a local property manager to assist with the day to day management of the property.

As Nannup continues to build its capacity for tourism with festivals and mountain bike trails, the provision of quality holiday accommodation in the area is a necessity. I look forward to showcasing our home as another reason to visit and stay in Nannup.

Please don't hesitate to contact me if you require any further information in regards to this application. I look forward to hearing from you in the near future.

Regards,

Mark Donnelly

NOTE:

- TOP OF FOOTINGS FOR PIERPOSTS TO CARPORT, VERANDAH & PORCH ARE TO BE 2c BELOW FINISHED PAVING LEVEL.
- LOCATION OF COYAN PILES IS INDICATIVE ONLY & MAY BE CHANGED AT BUILDER'S DISCRETION.
- CHALK OUTLINES & ROUND DOWNPIPPES THROUGHOUT.
- PROVIDE HOOP IRON HOLDING DOWN STRIPS TO AS 4055.
- FLYPOWDER & KEYLOCKS TO ALL ALUMINIUM WINDOWS AND SLIDING DOORS.
- R3.0 INSULATION TO FLAT AND RAKING CEILING AREAS OF HOUSE ONLY.
- DROP INTERNAL LEAF MINIMUM 25MM UNDER KITCHEN WINDOW FOR CABINET MAKER TO RUN BENCH TOP THROUGH TO FRAME.

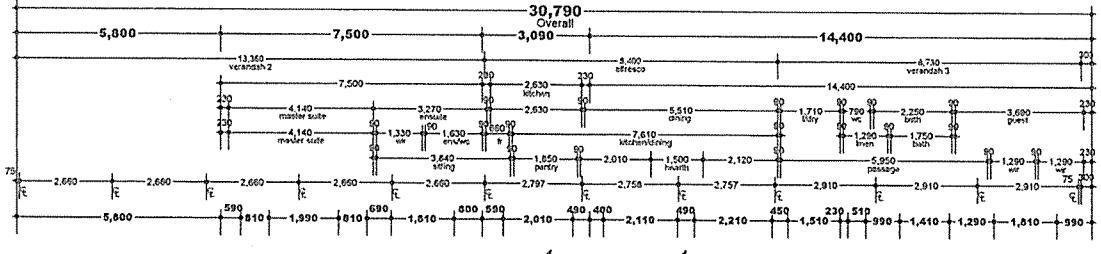

Location	Area (sq)	Perimeter (m)
ALFRESCO	38,530	25,920
CARPORT	31,870	22,520
HOUSE	215,170	68,880
VERANDAH 1	37,130	52,500
VERANDAH 2	27,920	30,820
VERANDAH 3	18,320	21,660
TOTAL AREA	364,760	222,980

ROOF AREA(S) ON FLAT:

- 25° 33' PITCHED ROOF = 289,70sqm
- 9° 09' PITCHED ROOF = 41,87sqm
- 7° 00' PITCHED ROOF = 51,02sqm
- TOTAL AREA = 382,59sqm**

NOTE: ALL DRAWINGS TO BE READ IN CONJUNCTION WITH ENGINEER'S DETAILS.

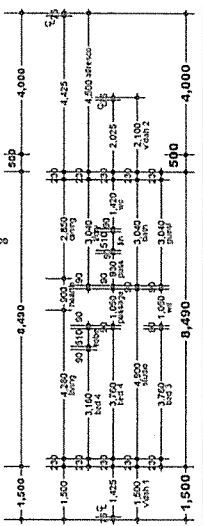
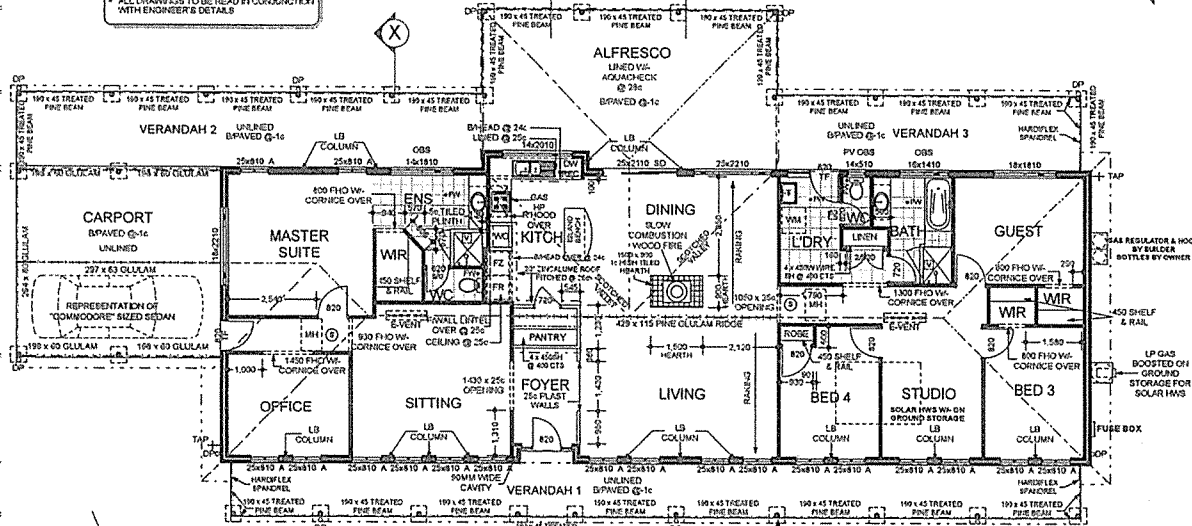
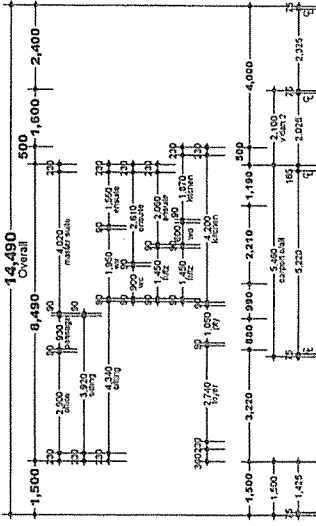

250w x 162 x 90 FACEBRICK BLOCKS TO EXTERNAL LEAF. BLOCKS ARE TO BE LAID IN THIRD STRETCHER BOND.

WIND CLASSIFICATION AS PER A.S. 4055: ND - FOR SINGLE STOREY RESIDENCE.

NOTE:

- METAL CORNER BEADS TO ALL PROJECTIONS PLASTERED CORNERS ON INTERNAL WALLS.
- PROVIDE INTERNAL PAINTING: 1 COAT SEALER, 2 TOP COATS.

⊙ DENOTES SMOKE DETECTOR

FLOOR PLAN
1:100

DURACK

© COPYRIGHT MODEL NO 3388

COUNTRY BUILDERS

SOUTHWEST SUNBURY

Unit 7 Homemaker Centre
Cnr Blair & Strickland Streets, Sunbury, W.A. 6230.
Telephone: (08) 9792 0100.
Facsimile: (08) 9792 0101.
P.O. Box 451, Sunbury, W.A. 6231.

REV	NO #	DRN	DATE	CHK
	1	PC VO 01	JA 09/01/08	RP
	2	Engineering	JA 06/02/08	DCP
	3	Engineering	JA 18/02/08	JA
	4	Wind Class	JA 11/03/08	JA

Sub-contractors to verify all dimensions on site.

THIS IS ONE OF THE DRAWINGS REFERRED TO IN THE CONTRACT.

DATED: _____

OWNER: _____ WITNESS: _____

BUILDER: _____ WITNESS: _____

CLIENT: T & K ATTWOOD
ADDRESS: Lot 101 Chalwell Road, NANNUP

SHEET NO: 1 OF 10
JOB NO: 18526 BNB
REVISION DATE: 4 11/03/08

SHARE COPY

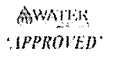

Bushfire Management Plan Coversheet

This Coversheet and accompanying Bushfire Management Plan has been prepared and issued by a person accredited by Fire Protection Association Australia under the Bushfire Planning and Design (BPAD) Accreditation Scheme.

Bushfire Management Plan and Site Details

Site Address / Plan Reference: Lot 101 on Plan 31673, 314 Chalwell Road

Suburb: Carlotta

State: WA

P/code: 6275

Local government area: Shire of Nannup

Description of the planning proposal: Development Application

BMP Plan / Reference Number: 230256

Version: v1.0

Date of Issue: 05/06/2023

Client / Business Name: Christine Donnelly

Reason for referral to DFES	Yes	No
Has the BAL been calculated by a method other than method 1 as outlined in AS3959 (tick no if AS3959 method 1 has been used to calculate the BAL)?	<input type="checkbox"/>	<input checked="" type="checkbox"/>
Have any of the bushfire protection criteria elements been addressed through the use of a performance principle (tick no if only acceptable solutions have been used to address all of the BPC elements)?	<input type="checkbox"/>	<input checked="" type="checkbox"/>
Is the proposal any of the following special development types (see SPP 3.7 for definitions)?		
Unavoidable development (in BAL-40 or BAL-FZ)	<input type="checkbox"/>	<input checked="" type="checkbox"/>
Strategic planning proposal (including rezoning applications)	<input type="checkbox"/>	<input checked="" type="checkbox"/>
Minor development (in BAL-40 or BAL-FZ)	<input type="checkbox"/>	<input checked="" type="checkbox"/>
High risk land-use	<input type="checkbox"/>	<input checked="" type="checkbox"/>
Vulnerable land-use	<input checked="" type="checkbox"/>	<input type="checkbox"/>

If the development is a special development type as listed above, explain why the proposal is considered to be one of the above listed classifications (E.g. considered vulnerable land-use as the development is for accommodation of the elderly, etc.)?

The site is considered vulnerable land use as it is a tourism development with occupants with a lesser capacity to respond to bushfires.

Note: The decision maker (e.g. local government or the WAPC) should only refer the proposal to DFES for comment if one (or more) of the above answers are ticked "Yes".

BPAD Accredited Practitioner Details and Declaration

Name Kathy Nastov	Accreditation Level Level 3	Accreditation No. BPAD27794	Accreditation Expiry 01/08/2023
Company Bushfire Prone Planning		Contact No. 64771144	

I declare that the information provided within this bushfire management plan is to the best of my knowledge true and correct

Signature of Practitioner

Date 05/06/2023



Bushfire Management Plan (BMP)



- ◇ *Assessment of potential bushfire impact*
- ◇ *Environmental conservation*
- ◇ *Assessment of the development's ability to acceptably mitigate bushfire risk through application of required and/or additional bushfire protection measures*
- ◇ *Creation of responsibilities to implement and maintain protection measures*

Produced to meet the relevant requirements of STATE PLANNING POLICY 3.7 Planning in Bushfire Prone Areas & associated Guidelines.

314 Chalwell Road, Carlotta

Shire of Nannup

**Development Application - Vulnerable
Tourism Land Use**

5 June 2023

Job Reference No: 230256

BPP GROUP PTY LTD T/A BUSHFIRE PRONE PLANNING

ACN: 39 166 551 784 | ABN: 39 166 551 784

**LEVEL 1, 159-161 JAMES STREET
GUILDFORD WA 6055****PO BOX 388
GUILDFORD WA 6935****08 6477 1144 | admin@bushfireprone.com.au****DOCUMENT CONTROL**

PREPARATION					
Co-Author:	Louise Stokes (BPAD Level 1 No. 5189)				
Original Author /Reviewed:	Kathy Nastov (BPAD Level 3 No. 27794)				
VERSION HISTORY					
Version	Details				Date
1.0	Original				5 June 2023
-	-				
BMP (Master) Template v9.1					
DISTRIBUTION					
Destination		Version	No. Copies	Hard Copy	Electronic Copy
Person	Email				
Christine Donnelly		1.0	1	<input type="checkbox"/>	<input checked="" type="checkbox"/>
<p>Limitations: The protection measures contained in this Bushfire Management Plan are minimum requirements and they do not guarantee that buildings or infrastructure will not be damaged in a bushfire, persons injured, or fatalities occur either on the subject site or off the site while evacuating. This is substantially due to the unpredictable nature and behaviour of fire and fire weather conditions. Additionally, the correct implementation of the recommended protection measures will depend upon, among other things, the ongoing actions of the landowners and/or operators over which Bushfire Prone Planning has no control.</p> <p>All surveys, forecasts, projections and recommendations made in this report associated with the proposed development are made in good faith based on information available to Bushfire Prone Planning at the time. All maps included herein are indicative in nature and are not to be used for accurate calculations.</p> <p>Notwithstanding anything contained therein, Bushfire Prone Planning will not, except as the law may require, be liable for any loss or other consequences whether or not due to the negligence of their consultants, their servants or agents, arising out of the services provided by their consultants.</p> <p>Copyright © 2022 BPP Group Pty Ltd: All intellectual property rights, including copyright, in format and proprietary content contained in documents created by Bushfire Prone Planning, remain the property of BPP Group Pty Ltd. Any use made of such format or content without the prior written approval of Bushfire Prone Planning, will constitute an infringement on the rights of the Company which reserves all legal rights and remedies in respect of any such infringement.</p>					

TABLE OF CONTENTS

SUMMARY STATEMENTS.....	3
1 PROPOSAL DETAILS AND THE BUSHFIRE MANAGEMENT PLAN.....	5
1.1 THE PROPOSED DEVELOPMENT/USE DETAILS, PLANS AND MAPS	5
1.2 THE BUSHFIRE MANAGEMENT PLAN (BMP).....	11
1.2.1 COMMISSIONING AND PURPOSE.....	11
1.2.2 OTHER RELEVANT DOCUMENTATION - EXISTING OR CONCURRENTLY DEVELOPED	11
2 ENVIRONMENTAL CONSERVATION (DESKTOP ASSESSMENT).....	12
2.1 EXISTING VEGETATION ON PRIVATE LAND	12
2.1.1 DECLARED ENVIRONMENTALLY SENSITIVE AREAS (ESA)	12
2.2 POST DEVELOPMENT VEGETATION - PLANNED LANDSCAPING AND/OR RE-VEGETATION	13
2.3 IDENTIFIED REQUIREMENT FOR ONSITE VEGETATION MODIFICATION OR REMOVAL	13
2.4 CULTURAL HERITAGE.....	14
3 BUSHFIRE ATTACK LEVEL (BAL) ASSESSMENT	16
3.1 BAL ASSESSMENT SUMMARY (TABLE FORMAT).....	17
3.1.2 SITE ASSESSMENT DATA AND BAL RESULTS	18
3.1.3 CLASSIFIED VEGETATION AND TOPOGRAPHY MAP	20
3.1.4 POST DEVELOPMENT MAP	21
4 IDENTIFICATION OF BUSHFIRE HAZARD ISSUES	22
5 ASSESSMENT AGAINST THE BUSHFIRE PROTECTION CRITERIA (GUIDELINES V1.4).....	23
5.1 BUSHFIRE PROTECTION CRITERIA ELEMENTS APPLICABLE TO THE PROPOSED DEVELOPMENT/USE	23
5.2 LOCAL GOVERNMENT VARIATIONS TO APPLY.....	23
5.3 ASSESSMENT STATEMENTS FOR ELEMENT 5: VULNERABLE TOURISM LAND USES	24
6. RESPONSIBILITIES FOR IMPLEMENTATION AND MANAGEMENT OF THE BUSHFIRE PROTECTION MEASURES	30
6.1 DEVELOPER/LANDOWNER RESPONSIBILITIES – PRIOR TO OPENING	30
6.2 LANDOWNER/OCCUPIER RESPONSIBILITIES – ONGOING MANAGEMENT.....	31
6.3 LOCAL GOVERNMENT –ONGOING MANAGEMENT.....	33
APPENDIX A: SUBJECT SITE BAL ASSESSMENT INFORMATION AND ADDITIONAL DATA.....	34
ASSESSED SITE INPUTS COMMON TO THE METHOD 1 AND METHOD 2 PROCEDURES	34
A1.1: FIRE DANGER INDICES (FDI/FDI/GFDI)	34
A1.2: VEGETATION ASSESSMENT AND CLASSIFICATION.....	34
A1.3: SEPARATION DISTANCE.....	42
APPENDIX B: ONSITE VEGETATION MANAGEMENT - THE APZ	43

B1:	THE DIMENSIONS AND LOCATION OF THE APZ TO BE ESTABLISHED AND MAINTAINED	43
B2:	THE STANDARDS FOR THE APZ AS ESTABLISHED BY THE GUIDELINES (DPLH, V1.4).....	44
B3:	THE STANDARDS FOR THE APZ AS ESTABLISHED BY THE LOCAL GOVERNMENT	45
B4:	MAINTAINING LOW THREAT AND NON-VEGETATED AREAS EXCLUDED FROM CLASSIFICATION	46
APPENDIX C:	TECHNICAL REQUIREMENTS FOR VEHICULAR ACCESS.....	47
APPENDIX D:	TECHNICAL REQUIREMENTS FOR FIREFIGHTING WATER SUPPLY.....	48
D2:	NON-RETICULATED AREAS – STATIC SUPPLY.....	48

LIST OF FIGURES

Figure 1.1:	Proposed Development	7
Figure 1.2:	Location Map.	8
Figure 1.3:	Map of Bushfire Prone Areas (Office of Bushfire Risk Management, DFES)	10
Figure 2.1:	Land identified with known environmental, biodiversity and conservation values.	15
Figure 3.1:	Classified vegetation and topography map (existing)	20
Figure 3.1.1:	Post development vegetation map	21

SUMMARY STATEMENTS

THIS DOCUMENT – STATEMENT OF PURPOSE

The Bushfire Management Plan (BMP)

The BMP sets out the required package of bushfire protection measures to lessen the risks associated with a bushfire event. It establishes the responsibilities to implement and maintain these measures.

The BMP also identifies the potential for any negative impact on any environmental, biodiversity and conservation values that may result from the application of bushfire protection measures or that may limit their implementation.

Risks Associated with Bushfire Events

The relevant risks are the potential for loss of life, injury, or destroyed or damaged assets which results in personal loss and economic loss. For a given site, the level of that risk to persons and assets (the exposed elements) is a function of the potential threat levels generated by the bushfire hazard, and the level of exposure and vulnerability of the at risk elements to the threats.

Bushfire Protection Measures

The required package of protection measures is established by *State Planning Policy 3.7 Planning in Bushfire Prone Areas (SPP 3.7)*, its associated *Guidelines* and any other relevant guidelines or position statements published by the Department of Planning, Lands and Heritage. These measures are limited to those considered by the WA planning authorities as necessary to be addressed for the purpose of land use planning. They do not encompass all available bushfire protection measures as many are not directly relevant to the planning approval stage. For example:

- Protection measures to reduce the vulnerability of buildings to bushfire threats is primarily dealt with at the building application stage. They are implemented through the process of applying the Building Code of Australia in accordance with WA building legislation and the application of construction requirements based on a building's level of exposure - determined as a Bushfire Attack Level (BAL) rating); or
- Protection measures to reduce the threat levels of consequential fire (ignited by bushfire and involving combustible materials surrounding and within buildings) and measures to reduce the exposure and vulnerability of elements at risk exposed to consequential fire, are not specifically considered.

The package of required bushfire protection measures established by the Guidelines includes:

- The requirements of the bushfire protection criteria which consist of:
 - Element 1: Location (addresses threat levels).
 - Element 2: Siting and Design of Development (addresses exposure levels of buildings).
 - Element 3: Vehicular Access (addresses exposure and vulnerability levels of persons).
 - Element 4: Water (addresses vulnerability levels of buildings).
 - Element 5: Vulnerable Tourism Land Uses (addresses exposure and vulnerability as per Elements 1-4 but in use specific ways and with additional considerations of persons exposure and vulnerability).
- The requirement to develop Bushfire Emergency Plans / Information for 'vulnerable' land uses for persons to prepare, respond and recover from a bushfire event (this addresses vulnerability levels).
- The requirement to assess bushfire risk and incorporate relevant protection measures into the site emergency plans for 'high risk' land uses (this addresses threat, exposure and vulnerability levels).

Compliance of the Proposed Development or Use with SPP 3.7 Requirements

The BMP assesses the capacity of the proposed development or use to implement and maintain the required 'acceptable' solutions and any additionally recommended bushfire protection measures - or its capacity to satisfy the policy intent through the justified application of additional bushfire protection measures as supportable 'alternative' solutions.

THE PROPOSED DEVELOPMENT/USE – BUSHFIRE PLANNING COMPLIANCE SUMMARY		
Environmental Considerations		Assessment Outcome
Will identified environmental, biodiversity and conservation values limit the full application of the required bushfire protection measures?		No
Will identified environmental, biodiversity and conservation values need to be managed in the implementation and maintenance of the bushfire protection measures - but not limit their application?		No
Required Bushfire Protection Measures		Assessment Outcome
The Acceptable Solutions of the Bushfire Protection Criteria (Guidelines)		
Element	The Acceptable Solutions	
B&B/Holiday House – outside RBA	A5.4a Siting and design - APZ	Fully Compliant
	A5.5a Vehicular access – multiple access routes	Not Compliant
	A5.5b Vehicular access – no-through roads – maximum length	Not Compliant
	A5.5c Vehicular access – EAW – alternative access option	Not Compliant
	A5.5d Vehicular access – public roads - technical requirements	Not Compliant
	A5.5e Vehicular access – private driveways – technical requirements	Fully Compliant
	A5.5f Vehicular access – signage	Fully Compliant
	A5.6a Provision of water - reticulated	N/A
	A5.6b Provision of water – non-reticulated	Fully Compliant

Other Documents to Be Produced	Required
[determined by the proposed development/use type and with relevant outcomes captured as responsibilities in the BMP]	
Bushfire Emergency Plan – as preparation, response, and recovery operational information document. Includes a supporting information document to justify the plan's content.	<input checked="" type="checkbox"/>
Bushfire Emergency Information – as response information poster.	<input checked="" type="checkbox"/>
Summary Statement: The Bushfire Emergency Information Poster will be displayed in the short stay accommodation.	
Bushfire Risk Assessment and Management Report	<input type="checkbox"/>

1 PROPOSAL DETAILS AND THE BUSHFIRE MANAGEMENT PLAN

1.1 The Proposed Development/Use Details, Plans and Maps

Planning Stage:	Development Application
The stated bushfire planning land use for which additional assessments and documents are required, will apply.	Vulnerable Tourism Land Use
Factors that have identified the proposal's bushfire planning land use classification:	<p>The proposed development is a land use that can be categorised as a:</p> <p>Bed and breakfast and holiday house outside a residential built out area.</p> <p>The proposed land use for tourism or recreation involves visitors who are unfamiliar with the surroundings and/or presents evacuation challenges.</p>
Subject lot/site total area:	35,258 m ²
Number of additional lots being created:	N/A
Description of the proposed development/use:	
<p>This Bushfire Management Plan has been prepared for Christine Donnelly, who is submitting a Development Application for short stay accommodation of 314 Chalwell Road, Carlotta.</p> <p>The property is located in an area of Extreme fire danger, with Forest vegetation surrounding the development site on three sides. As a Tourism Land Use the proposed development is by default also considered a Vulnerable Land Use and the emphasis will be on early evacuation as the primary emergency procedure.</p> <p>The BAL post vegetation map has been derived for the proposed development on the subject site. The purpose is to inform future development planning by determining or indicating the Bushfire Attack Levels (BAL's) that future buildings, within the development site are potentially subject to.</p> <p>The Shire of Nannup requires a 20m APZ around all buildings. This has been applied and can be viewed on Fig 3.1.1 (post development)</p> <p>The proposal requires the application of State Planning Policy No. 3.7: Planning in Bushfire Prone Areas (SPP 3.7). The assessed bushfire risk is manageable and will be achieved by the identified stakeholders implementing and maintaining the bushfire risk management measures that are presented in this Plan.</p> <p>Against the Bushfire Protection Criteria, the decision marker's assessment of a future Proposal will be on the basis of it being able to meet the Acceptable Solution is complete as follows:</p> <ul style="list-style-type: none"> For Element 1 'Siting and Design': the existing building can achieve an Asset Protection Zone (APZ) of sufficient size to ensure the radiant heat impact does not exceed BAL-29. Significant clearing is required to achieve this; however, most of the vegetation is re-growth. For Element 2 'Vehicular Access': The technical requirements for internal driveways can be achieved with additional work completed. Chalwell Road is a no-through road, as the link to Mount Leewin Loop Road travels through private property as a forestry track. Whilst locals use it as a shortcut to Graphite Road it is not advised that visitors use this road as there are many tracks off the main track and it is easy to get lost. Chalwell Road to Nannup via Vasse Highway complies with the technical construction requirements of a no through road. A second access/egress way may need to be installed (at the discretion of the Local Government) however this would come back onto Graphite Road on a corner, so doesn't really serve any purpose. As 	

Element 2 is non-compliant and there is no available space to construct an onsite shelter it is recommended that early evacuation is the primary message for guests.

- For Element 3 'Provision of Water': the Proposal can achieve the acceptable solution. There are number of water tanks on the property that are constructed of non-flammable material. The tank closest to the house is best suited to be dedicated for firefighting purposes as it has a larger turn around area for firefighting appliances. As additional clearing is required for the APZ, the turn around area for firefighting appliances can be achieved next to the dedicated firefighting tank. Both tanks are close to the driveway, house and shed. Coupling and piping will need to be replaced as per Appendix D in this BMP.

Early evacuation is the primary message for guests, and it is recommended that on days of Extreme fire danger that guests depart the property for the day or if there is a fire in the vicinity. The Bushfire Evacuation Plan outlays the triggers for evacuation.

It is also recommended that a Bushfire Compliance Report is commissioned by prior to the short stay accommodation commencing.

Development and management of potential bushfire hazard issues:

314 Chalwell Road is located on a downslope in Forest vegetation, within an Extreme fire danger area. The neighbouring property across the road has a pine plantation with elevated fuel loads. Further afield, the property is surrounded by native forest. Chalwell Road itself is a winding road with Forest vegetation on both verges.

Potential bushfire hazards identified include the remote location within a high bushfire area. Visitors may not be familiar with the terrain and speed at which a bushfire can travel through the region, due to the vegetation type.

Figure 1.1
Proposed Development

Lot 101 on Plan 31 673, Area : 30,258 sq m
 314 Chalwell Road,
 CARLOTTA 6275
SHIRE OF NANNUP



----- **LEGEND** -----

-  Subject Site
-  Other Lots
-  Driveways
- Existing Building**
-  Dwelling
-  Shed
-  Water Tank

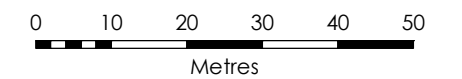

----- **LOCALITY** -----

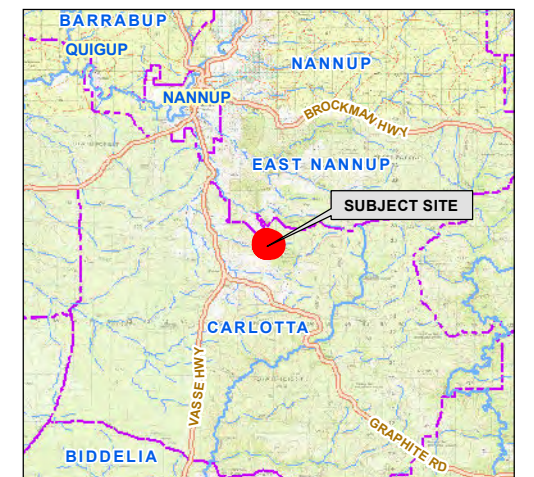

Aerial Imagery : Landgate/SLIP
 Image Date : 2017

Coordinate System: GDA 1994 MGA Zone 50
 Projection: Universal Transverse Mercator Units: Metre
 Map compiled by: Ian Ross 12/05/2023
 Map updated by: Ian 12/05/2023
 A3 Scale 1:1,000





Figure 1.2
Location Plan

Lot 101 on Plan 31 673, Area : 30,258 sq m
314 Chalwell Road,
CARLOTTA 6275
SHIRE OF NANNUP

----- LEGEND -----

- Subject Site
- Bush Fire Brigade
- State Emergency Service Unit
- Volunteer Fire & Rescue Service

Reserves

- Reserves

Legislated Lands and Waters

- Section 34A Freehold
- Timber Reserve
- National Park
- Section 5(1)(h) Reserve
- State Forest

DBCAs Lands of Interest

- Crown Freehold - Dept Interest



----- LOCALITY -----

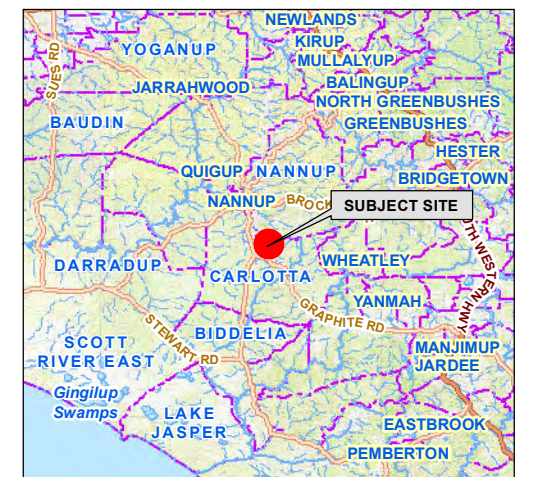

Aerial Imagery : Landgate/SLIP
Image Date : 2017

Coordinate System: GDA 1994 MGA Zone 50
Projection: Universal Transverse Mercator Units: Metre
Map compiled by: Ian Ross 6/06/2023
Map updated by: Ian 6/06/2023
A3 Scale 1:75,000



WHERE SPP 3.7 AND THE GUIDELINES ARE TO APPLY – DESIGNATED BUSHFIRE PRONE AREAS

All higher order strategic planning documents, strategic planning proposals, subdivisions and development applications located in designated bushfire prone areas need to address SPP 3.7 and its supporting Guidelines. This also applies where an area is not yet designated as bushfire prone but is proposed to be developed in a way that introduces a bushfire hazard.

For development applications where only part of a lot is designated as bushfire prone and the proposed development footprint is wholly outside of the designated area, the development application will not need to address SPP 3.7 or the Guidelines. (Guidelines DPLH 2021 v1.4, s1.2).

For subdivision applications, if all the proposed lots have a BAL-LOW indicated, a BMP is not required. (Guidelines DPLH 2021 v1.4, s5.3.1).

Figure 1.3
Bushfire Prone Area

Lot 101 on Plan 31 673, Area : 30,258 sq m
 314 Chalwell Road,
 CARLOTTA 6275
SHIRE OF NANNUP



----- **LEGEND** -----

- Subject Site
- Other Lots
- Driveways
- Existing Building**
- Dwelling
- Shed
- Water Tank
- Bush Fire Prone Areas**
- Bushfire Prone Areas (2021)

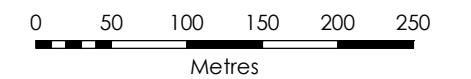

----- **LOCALITY** -----

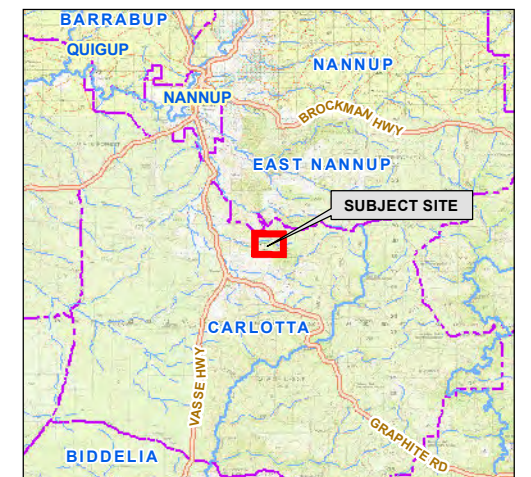

Aerial Imagery : Landgate/SLIP
 Image Date : 2017

Coordinate System: GDA 1994 MGA Zone 50
 Projection: Universal Transverse Mercator Units: Metre
 Map compiled by: Ian Ross 6/06/2023
 Map updated by: Ian 6/06/2023
 A3 Scale 1:5,000



1.2 The Bushfire Management Plan (BMP)

1.2.1 Commissioning and Purpose

Landowner / proponent:	Christine Donnelly
Bushfire Prone Planning commissioned to produce the BMP by:	Christine Donnelly
Purpose of the BMP:	To apply the requirements established by State Planning Policy 3.7: Planning in Bushfire Prone Areas (SPP 3.7) and accompany the development application.
BMP to be submitted to:	Shire of Nannup

1.2.2 Other Relevant Documentation - Existing or Concurrently Developed

This section identifies any known assessments, reports or plans that have been conducted and prepared previously, or are being prepared concurrently, and are relevant to the subject site and the proposal/application. They potentially have implications for the assessment of bushfire threats and the implementation of the protection measures that are dealt with in the Bushfire Management Plan.

Table 1.1: Existing or concurrently developed relevant documentation.

RELEVANT DOCUMENTS			
Existing Document	Relevant to the Proposal and the BMP	Copy Provided by Proponent / Developer	Title
Structure Plan	No	N/A	-
Bushfire Management Plan	No	N/A	
Bushfire Emergency Plan or Information	Yes	N/A	230256 – Bushfire Emergency Evacuation Plan
Bushfire Emergency Plan Supporting Information	No	N/A	
Bushfire Risk – Assessment and Management Report	No	N/A	
Environmental Asset or Vegetation Survey	No	N/A	-
Landscaping (Revegetation) Plan	No	N/A	-
DPLH BMP Guidance 'Regions & Uses'	No	N/A	-

2 ENVIRONMENTAL CONSERVATION (DESKTOP ASSESSMENT)

Important: This 'desktop' assessment must not be considered as a replacement for a full Environmental Impact Assessment. It is a summary of potential environmental values at the subject site, inferred from information contained in listed datasets and/or reports, which are only current to the date of last modification.

These data sources must be considered indicative where the subject site has not previously received a site-specific environmental assessment by an appropriate professional.

Many bushfire prone areas also have high biodiversity values. Consideration of environmental priorities within the boundaries of the land being developed can avoid excessive or unnecessary modification or clearing of vegetation. Approval processes (and exemptions) apply at both Commonwealth and State levels.

Any 'modification' or 'clearing' of vegetation to reduce bushfire risk is considered 'clearing' under the **Environmental Protection Act 1986** (EP Act) and requires a clearing permit under the **Environmental Protection (Clearing of Native Vegetation) Regulations 2004** (Clearing Regulations) – unless for an exempt purpose.

Clearing native vegetation is an offence, unless done under a clearing permit or the clearing is for an exempt purpose. Exemptions are contained in the EP Act or are prescribed in the Clearing Regulations (note: these do not apply in environmentally sensitive areas).

The **Department of Water and Environmental Regulation** (DWER) is responsible for issuing 'clearing' permits and the framework for the regulation of clearing. Approvals under other legislation, from other agencies, may also be required, dependent on the type of flora or fauna present.

Local Planning Policy or Local Biodiversity Strategy: Natural areas that are not protected by the above Act and Regulations (or any other National or State Acts) may be protected by a local planning policy or local biodiversity strategy. Permission from the local government will be required for any modification or removal of native vegetation in these Local Natural Areas (LNA's). Refer to the relevant local government for detail.

For further Information refer to Guidelines v1.4, the Bushfire and Vegetation Factsheet - WAPC, Dec 2021 and <https://www.der.wa.gov.au/our-work/clearing-permits>

2.1 Existing Vegetation on Private Land

2.1.1 Declared Environmentally Sensitive Areas (ESA)

Table 2.1: Identification of relevant ESA.

IDENTIFICATION OF ESA							
ESA Class	Relevant to Proposal	Influence on Bushfire Threat Levels and / or Application of Bushfire Protection Measures	Relevant Dataset	Information Source(s) Applied to Identification of Relevant Vegetation			Further Action Required
				Dataset	Landowner or Developer	Environmental Asset or Vegetation Survey	
Wetlands and their 50m Buffer (Ramsar, conservation category and nationally important)	No	N/A	DBCA-010 and 011, 019, 040, 043, 044	<input checked="" type="checkbox"/>	<input type="checkbox"/>	<input type="checkbox"/>	None
Bush Forever	No	N/A	DPLH-022, SPP 2.8	<input checked="" type="checkbox"/>	<input type="checkbox"/>	<input type="checkbox"/>	None

Threatened and Priority Flora + 50m Continuous Buffer	No	No	DBCA-036	Restricted Scale of Data Available (security)	<input type="checkbox"/>	<input type="checkbox"/>	Confirm with relevant agency
Threatened Ecological Community	No	No	DBCA-038		<input type="checkbox"/>	<input type="checkbox"/>	Data not available - confirm with relevant agency
Heritage Areas National / World	Yes	No	Relevant register or mapping	<input checked="" type="checkbox"/>	<input checked="" type="checkbox"/>	<input type="checkbox"/>	Confirm with relevant agency
Environmental Protection (Western Swamp Tortoise) Policy 2002	No	No	DWER-062	<input checked="" type="checkbox"/>	<input type="checkbox"/>	<input type="checkbox"/>	N/A

DESCRIPTION OF THE IDENTIFIED AREA(S) OF VEGETATION

The relevant State agencies should be further consulted, and details confirmed as part of due diligence for the proposal.

2.2 Post Development Vegetation - Planned Landscaping and/or Re-vegetation

Table 2.2: Identification of land subject to planned vegetation modification.

AREAS OF LAND PLANNED FOR RE-VEGETATION OR LANDSCAPING			
Land with Environmental, Biodiversity, Conservation and Social Values	Relevant to Proposal	Planned Vegetation Modification	Description
Riparian Zones	No	N/A	
Foreshore Areas	No	N/A	-
Wetland Buffers	No	N/A	-
Legislated Lands	No	N/A	-
Public Open Space	No	N/A	-
Road Verges	No	N/A	-

2.3 Identified Requirement for Onsite Vegetation Modification or Removal

IDENTIFICATION OF POTENTIAL NATIVE VEGETATION MODIFICATION OR REMOVAL	
Has a requirement to modify or remove native vegetation to establish the required bushfire protection measures on the subject site been identified?	No
Is evidence provided (from relevant agencies, the environmental or planning consultant and/or the local government), that the required modification or removal of the vegetation can be achieved?	No

2.4 Cultural Heritage

IDENTIFIED AREAS OF LAND HERITAGE VALUE		
Land with Heritage Value	Relevant to Proposal	Description and Potential Impact on Implementation of Bushfire Protection Measures
Aboriginal Heritage Places (DPLH)	No	
National Heritage List (Dept. of Agriculture, water and the Environment)	No	
Comments: Not applicable		

Figure 2.1
Environmental Considerations

Lot 101 on Plan 31 673, Area : 30,258 sq m
 314 Chalwell Road,
 CARLOTTA 6275
SHIRE OF NANNUP



----- **LEGEND** -----

- Subject Site
- Other Lots
- Driveways

Existing Building

- Dwelling
- Shed
- Water Tank

Legislated Lands and Waters

- Timber Reserve

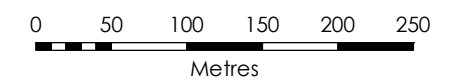

----- **LOCALITY** -----

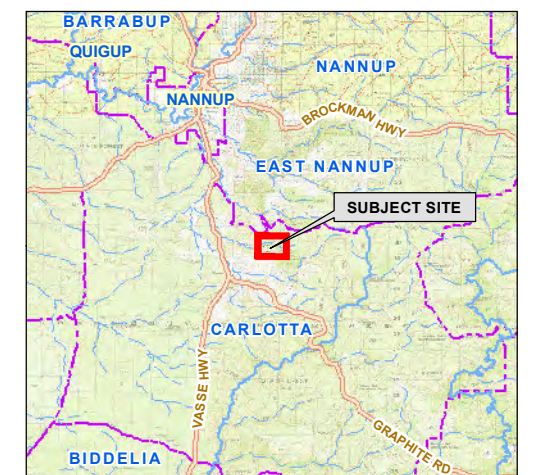

Aerial Imagery : Landgate/SLIP
 Image Date : 2017

Coordinate System: GDA 1994 MGA Zone 50
 Projection: Universal Transverse Mercator Units: Metre
 Map compiled by: Ian Ross 6/06/2023
 Map updated by: Ian 6/06/2023
 A3 Scale 1:5,000



3 BUSHFIRE ATTACK LEVEL (BAL) ASSESSMENT

BUSHFIRE ATTACK LEVELS (BAL) - UNDERSTANDING THE RESULTS

The transfer (flux/flow) of radiant heat from the bushfire to a receiving object is measured in kW/m². The AS 3959:2018 BAL determination methodology establishes the ranges of radiant heat flux that correspond to each bushfire attack level. These are identified as BAL-LOW, BAL-12.5, BAL-19, BAL-29, BAL-40 and BAL-FZ.

The bushfire performance requirements for certain classes of buildings are established by the Building Code of Australia (Vol. 1 & 2 of the NCC). The BAL will establish the bushfire resistant construction requirements that are to apply in accordance with AS 3959:2018 - Construction of buildings in bushfire prone areas and the NASH Standard – Steel framed construction in bushfire areas (NS 300 2021), whose solutions are deemed to satisfy the NCC bushfire performance requirements.

DETERMINED BAL RATINGS

A BAL Certificate can be issued for a determined BAL. A BAL can only be classed as 'determined' for an existing or future building/structure when:

1. It's final design and position on the lot are known and the stated separation distance from classified bushfire prone vegetation exists and can justifiably be expected to remain in perpetuity; or
2. It will always remain subject to the same BAL regardless of its design or position on the lot after accounting for any regulatory or enforceable building setbacks from lot boundaries as relevant and necessary (e.g., R-codes, restrictive covenants, defined building envelopes) or the retention of any existing classified vegetation either onsite or offsite.

If the BMP derives determined BAL(s), the BAL Certificate(s) required for submission with building applications can be provided, using the BMP as the assessment evidence.

INDICATIVE BAL RATINGS

A BAL Certificate cannot be issued for an indicative BAL. A BAL will be classed as 'indicative' for an existing or future building/structure when the required conditions to derive a determined BAL are not met.

This class of BAL rating indicates what BAL(s) could be achieved and the conditions that need to be met are stated.

Converting the indicative BAL into a determined BAL is conditional upon the currently unconfirmed variable(s) being confirmed by a subsequent assessment and evidential documentation. These variables will include the future building(s) location(s) being established (or changed) and/or classified vegetation being modified or removed to establish the necessary vegetation separation distance. This may also be dependent on receiving approval from the relevant authority for that modification/removal.

BAL RATING APPLICATION – PLANNING APPROVAL VERSUS BUILDING APPROVAL

1. **Planning Approval:** SPP.3.7 establishes that where BAL- LOW to BAL-29 will apply to relevant future construction (or existing structures for proposed uses), the proposed development may be considered for approval (dependent on the other requirements of the relevant policy measures being met). That is, BAL40 or BAL-FZ are not acceptable on planning grounds (except for certain limited exceptions).

Because planning is looking forward at what can be achieved, as well as looking at what may currently exist, both determined and indicative BAL ratings are acceptable assessment outcomes on which planning decisions can be made (including conditional approvals).

2. **Building Approval:** The Building Code of Australia (Vol. 1 & 2 of the NCC) establishes that relevant buildings in bushfire prone areas must be constructed to the bushfire resistant requirements corresponding to the BAL rating that is to apply to that building. Consequently, a determined BAL rating and the BAL Certificate is required for a building permit to be issued - an indicative BAL rating is not acceptable.

3.1 BAL Assessment Summary (Table Format)

3.1.1 The BAL Determination Methodology and Location of Data and Results

LOCATION OF DATA & RESULTS					
BAL Determination Methodology		Location of the Site Assessment Data			Location of the Results
AS 3959:2018	Applied to Assessment	Classified Vegetation and Topography Map(s)	Calculation Input Variables		Assessed Bushfire Attack Levels and/or Radiant Heat Levels
			Summary Data	Detailed Data with Explanatory and Supporting Information	
Method 1 (Simplified)	Yes	Figure 3.1	Table 3.1	Appendix A1	Table 3.1 and Table 3.2
Method 2 (Detailed)	No	-	-	-	

3.1.2 Site Assessment Data and BAL Results

Table 3.1: Summary of applied calculation input variables applied to deriving the BAL rating for the identified exposed element (the relevant building/structure).

DATA APPLIED TO THE DERIVATION OF THE BUSHFIRE ATTACK LEVELS (BAL) ¹							
BAL Determination Method	METHOD 1 - AS 3959:2018 CLAUSE 2.2 - SIMPLIFIED PROCEDURE				Applied Fire Danger Index		FDI 80
The Receiver of Radiant Heat Relevant Building(s) / Structure(s) and Their Location	Vegetation Classification		Effective Slope		Separation Distance		Bushfire Attack Level (AS 3959:2018 Table 2.5)
	Area	Class	Measured	Applied Range	Total		
			degrees	degree range	metres		
Existing residence	1	(A) Forest	flat 0	Upslope or flat 0	7m		BAL-FZ
	2	(G) Grassland	flat 0	Upslope or flat 0	37m		BAL-12.5
	3	(A) Forest	d/slope 14.6	Downslope >10-15	12m		BAL-FZ
	4	(A) Forest	d/slope 3.2	Downslope >0-5	5m		BAL-FZ
	5	Excluded cl 2.2.3.2(e & f)	-	-	-		-
	Determined Bushfire Attack Level						
<p>¹ All data and information supporting the determination of the classifications and values stated in this table and any associated justification, is presented in Appendix A.</p> <p>² This is the minimum building setback (i.e., the distance from a proposed building to the lot boundary) that is established by either the applicable R-code setback or another mechanism (e.g., restricted covenant), that is to apply to the proposed building/structure on the relevant lot. It is identified as a fixed component of the total separation distance from vegetation when its application is important to be identified because it establishes the closest distance to the lot boundary that a building/structure can legally exist. In other words, it identifies the part of the lot on which development cannot occur. When it is not critical for this distance to be identified, just the total separation distance is stated.</p>							

Table 3.2: Building setback distances required to achieve target BAL.

TARGET BUSHFIRE ATTACK LEVELS FOR FUTURE BUILDINGS AND CORRESPONDING BUILDING SETBACK REQUIRED ¹							
Relevant Building	Area	Relevant Vegetation Area/s ¹	Highest BAL Contour Impacting the building	Target BAL	Required Minimum Building Setback and its Components		
					Total Setback	Required Separation Distance	Additional Setback Required
					metres	metres	metres
Existing Residence	1	(A) Forest	BAL-FZ	BAL-29	7m	21	14
	2	(G) Grassland	BAL-12.5	N/A	37m	8	0
	3	(A) Forest	BAL-FZ	BAL-29	12m	42	30
	4	(A) Forest	BAL-FZ	BAL-29	5m	27	6
¹ The vegetation area(s) that generate the highest BAL impacting the lot.							

Figure 3.1
Classified Vegetation & Topography
 Lot 101 on Plan 31 673, Area : 30,258 sq m
 314 Chalwell Road,
 CARLOTTA 6275
SHIRE OF NANNUP

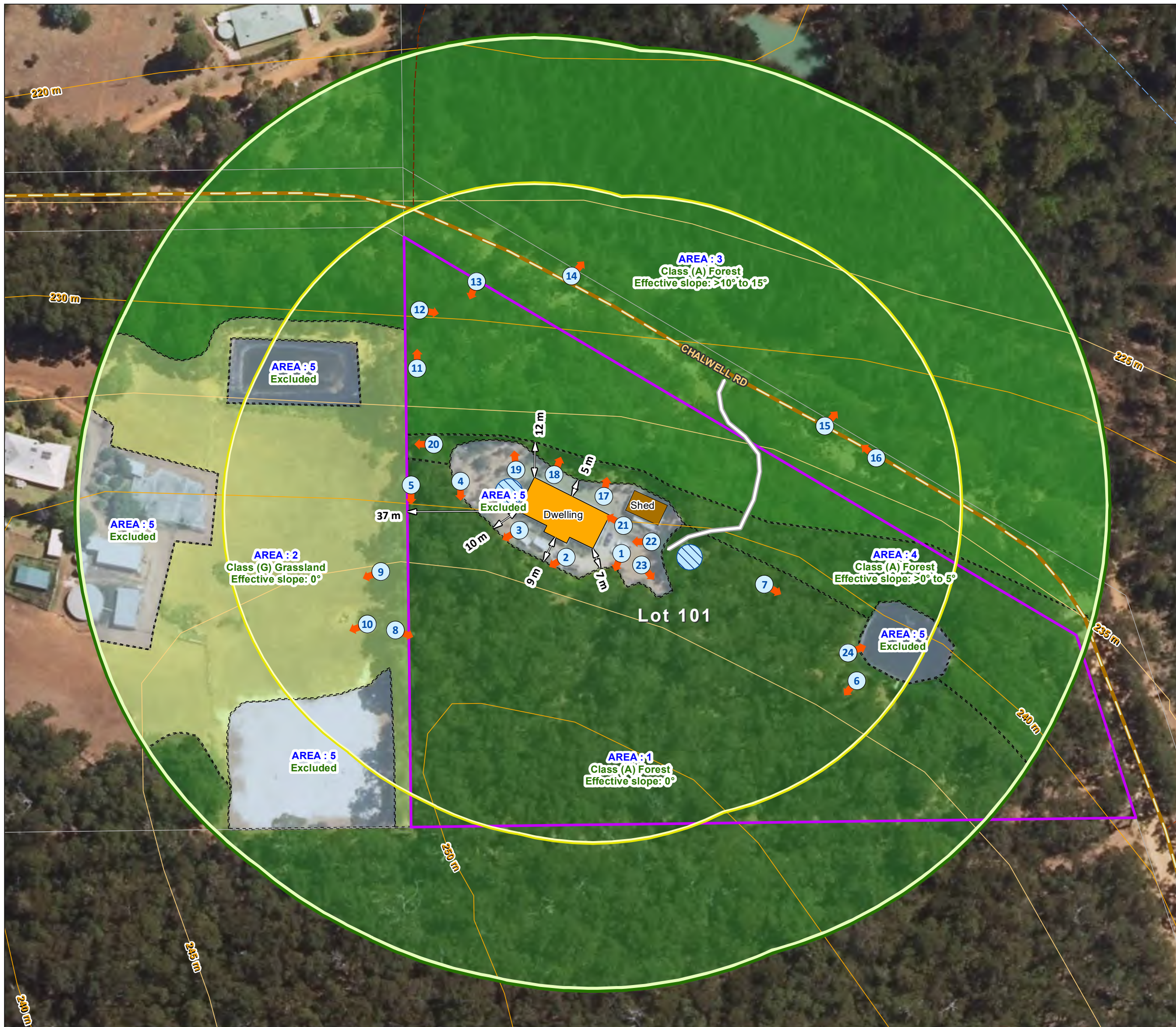

----- **LEGEND** -----

- Subject Site
- Other Lots
- ↔ Photo & Direction
- Driveways

Existing Building

- Dwelling
- Shed
- Water Tank

150m Vegetation Assessment Area

- 150m from Subject Site

100m Vegetation Assessment Area

- 100m from Subject Site

Classified Vegetation

- Class (A) Forest
- Class (G) Grassland
- Exempt 2.2.3.2

↔ Vegetation Distance

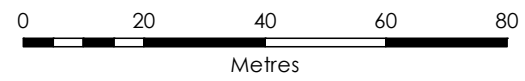

----- **LOCALITY** -----

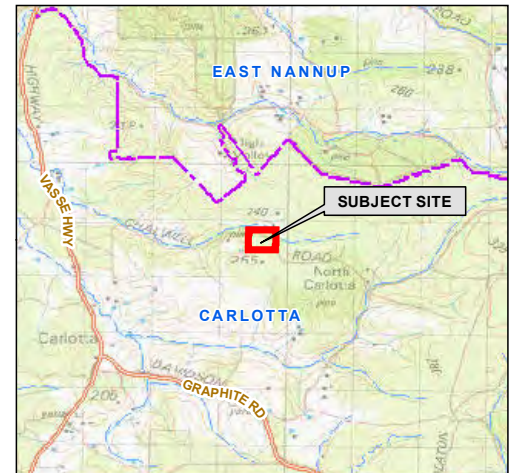

Aerial Imagery : Landgate/SLIP
 Image Date : 2017

Coordinate System: GDA 1994 MGA Zone 50
 Projection: Universal Transverse Mercator Units: Metre
 Map compiled by: Ian Ross 13/06/2023
 Map updated by: Ian Ross 13/06/2023
 A3 Scale 1:1,250

Disclaimer and Limitation: This map has been prepared for bushfire management planning purposes only. All depicted areas, contours and any dimensions shown are subject to survey. Bushfire Prone Planning does not guarantee that this map is without flaw of any kind and disclaims all liability for any errors, loss or other consequence arising from relying on any information depicted.
 Map Document Path / Name: K:\Projects\Jobs 2023\230256 - 314 Chalwell Road Carlotta (BMP BEI STA)\Mapping\MXD\230256_Fig3-1_VEG_314 Chalwell Road Carlotta.mxd

Figure 3.1.1
Classified Vegetation & Topography (Post Development)

Lot 101 on Plan 31 673, Area : 30,258 sq m
 314 Chalwell Road,
 CARLOTTA 6275
SHIRE OF NANNUP

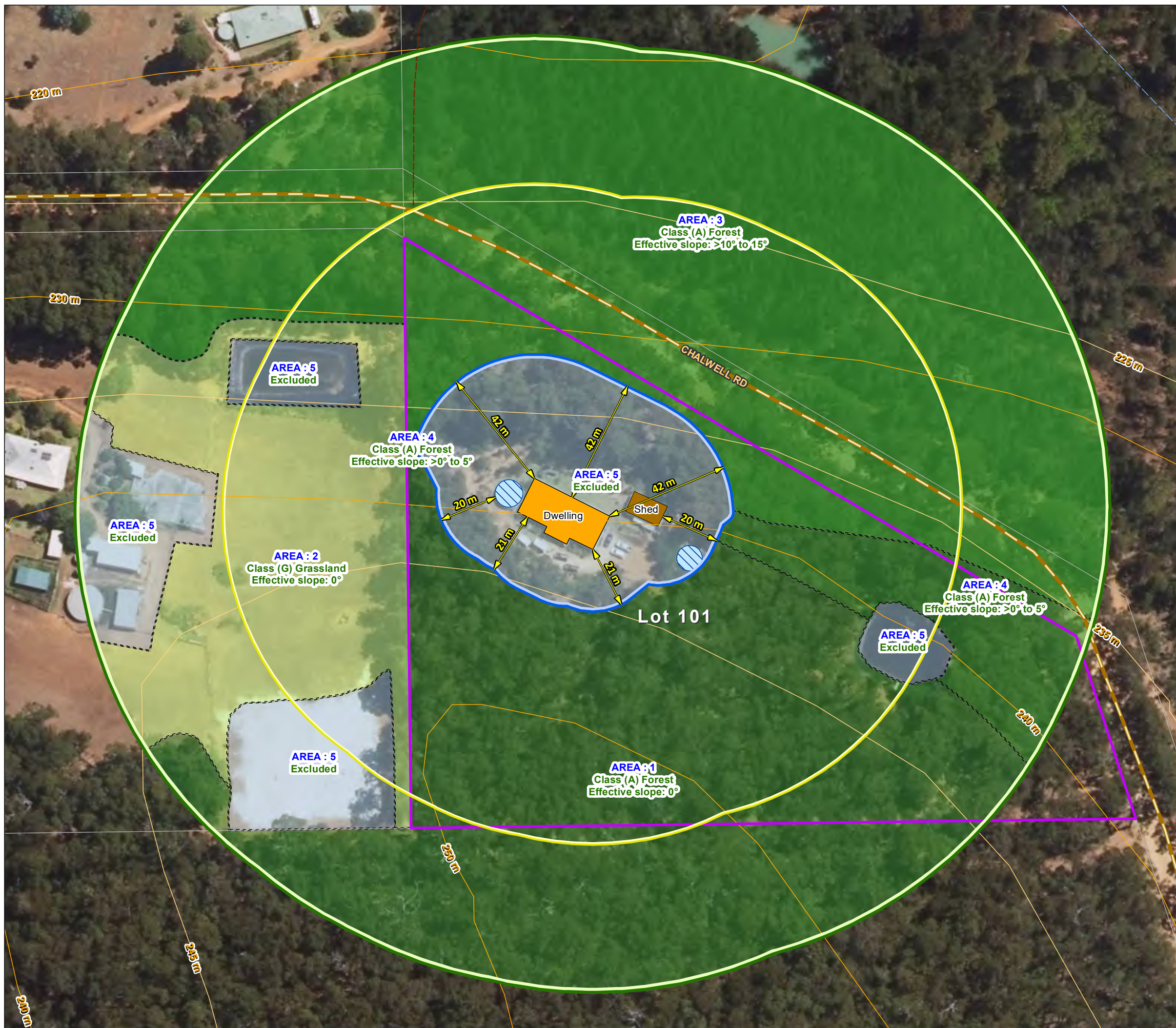

----- LEGEND -----

- Subject Site
- Other Lots
- Asset Protection Zone**
- 'Landowner' APZ
- APZ Distance
- Existing Building**
- Dwelling
- Shed
- Water Tank
- 150m Vegetation Assessment Area**
- 150m from Subject Site
- 100m Vegetation Assessment Area**
- 100m from Subject Site
- Classified Vegetation**
- Class (A) Forest
- Class (G) Grassland
- Exempt 2.2.3.2

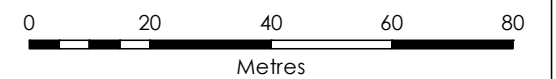

----- LOCALITY -----

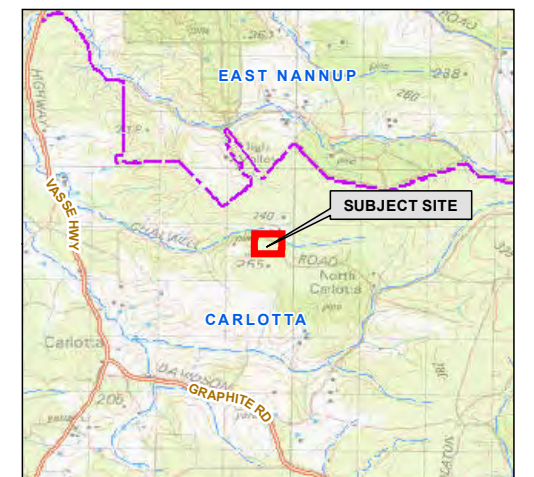

Aerial Imagery : Landgate/SLIP
 Image Date : 2017

Coordinate System: GDA 1994 MGA Zone 50
 Projection: Universal Transverse Mercator Units: Metre
 Map compiled by: Ian Ross 23/06/2023
 Map updated by: Ian Ross 23/06/2023
 A3 Scale 1:1,250



4 IDENTIFICATION OF BUSHFIRE HAZARD ISSUES

The Guidelines for Planning in Bushfire Prone Areas (WAPC 2021 v1.4), Appendix 5, establish that the application of this section of the BMP is intended to support **strategic planning** proposals. At the strategic planning stage there will typically be insufficient proposed development detail to enable all required assessments, including the assessment against the bushfire protection criteria.

Strategic Planning Proposals

If the proposed development is at this stage of planning, this section of the BMP will identify:

- Issues associated with the level of the threats presented by any identified bushfire hazard;
- Issues associated with the ability to implement sufficient and effective bushfire protection measures to reduce the exposure and vulnerability levels (of elements exposed to the hazard threats), to a tolerable or acceptable level; and
- Issues that will need to be considered at subsequent planning stages.

Other Planning Proposals

For all other planning stages the following issues are addressed in other sections of this BMP:

- environmental, biodiversity and conservation values;
- The bushfire threats – with the focus on flame contact and radiant heat; and
- The ability of the proposed development to apply the required bushfire protection measures thereby enabling it to be considered for planning approval.

These section include:

- Section 2 – Environmental Conservation;
- Section 3 – Potential Bushfire Impact; and
- Section 5 – Assessment Against the Bushfire Protection Criteria. Including the guidance provided by the *Position Statement: 'Planning in bushfire prone areas – Demonstrating Element 1: Location and Element 2'*.

Is the proposed development a strategic planning proposal?

No

5 ASSESSMENT AGAINST THE BUSHFIRE PROTECTION CRITERIA (GUIDELINES V1.4)

5.1 Bushfire Protection Criteria Elements Applicable to the Proposed Development/Use

APPLICATION OF THE CRITERIA, ACCEPTABLE SOLUTIONS AND PERFORMANCE ASSESSMENT

The criteria are divided into five elements – location, siting and design, vehicular access, water and vulnerable tourism land uses. Each element has an intent outlining the desired outcome for the element and reflects identified planning and policy requirements in respect of each issue.

The example acceptable solutions (bushfire protection measures) provide one way of meeting the element's intent. Compliance automatically achieves the element's intent and provides a straightforward pathway for assessment and approval.

Where the acceptable solutions cannot be met, the ability to develop design responses (as alternative solutions that meet bushfire performance requirements) is an alternative pathway that is provided by addressing the applicable performance principles (as general statements of how best to achieve the intent of the element).

A merit based assessment is established by the SPP 3.7 and the Guidelines as an additional alternative pathway along with the ability of using discretion in making approval decisions (sections 2.5, 2.6 and 2.7). This is formally applied to certain development (minor and unavoidable – sections 5.4.1 and 5.7). Relevant decisions by the State Administrative Tribunal have also supported this approach more generally.

Elements 1 – 4 should be applied for all strategic planning proposals, subdivision or development applications, except for vulnerable tourism land uses which should refer to Element 5. Element 5 incorporates the bushfire protection criteria in Elements 1 – 4 but caters them specifically to tourism land uses. (Guidelines DPLH 2021v1.4)

The Bushfire Protection Criteria	Applicable to the Proposed Development/Use
Element 1: Location	No
Element 2: Siting and Design	No
Element 3: Vehicular Access	No
Element 4: Water	No
Element 5: Vulnerable Tourism Land Uses	Yes

5.2 Local Government Variations to Apply

Local governments may add to or modify the acceptable solutions to recognise special local or regional circumstances (e.g., topography / vegetation / climate). These are to be endorsed by both the WAPC and DFES before they can be considered in planning assessments. (Guidelines DPLH 2021v1.4).

Do endorsed regional or local variations to the acceptable solutions apply to the assessments against the Bushfire Protection Criteria for the proposed development /use?	None known or identified
---------------------------------------------------------------------------------------------------------------------------------------------------------------------------	--------------------------

5.3 Assessment Statements for Element 5: Vulnerable Tourism Land Uses

5.3.1 B&B / Holiday House Outside Built-Out Area

VULNERABLE TOURISM	
Element Intent	To provide bushfire protection for tourism land uses relevant to the characteristics of the occupants and/or the location, to preserve life and reduce the impact of bushfire on property and infrastructure.
Proposed Development/Use – Relevant Type	Bed and breakfast and holiday house <u>outside</u> a residential built out area.
Element Compliance Statement	The proposed development cannot comply with all applicable acceptable solutions. An alternative solution cannot be provided. The intent of the element cannot be achieved.
Pathway Applied to Provide an Alternative Solution	N/A
Acceptable Solutions - Assessment Statements	
<p>All details of acceptable solution requirements are established in the Guidelines for Planning in Bushfire Prone Areas, DPLH v1.4 (Guidelines) and apply the guidance established by the 'Bushfire Management Plan Guidance for the Dampier Peninsula' (WA Department of Planning, Lands and Heritage, 2021 Rev B) as relevant. These documents are available at https://www.wa.gov.au/government/document-collections/state-planning-policy-37-planning-bushfire-prone-areas.</p> <p>The technical construction requirements for access types and components, and for each firefighting water supply component, are also presented in Appendices 2 and 3. The local government will advise the proponent where different requirements are to apply and when any additional specifications such as those for signage and gates are to apply (these are included in the relevant appendix if requested by the local government).</p>	
Solution Component Check Box Legend	<input checked="" type="checkbox"/> Relevant & met <input checked="" type="checkbox"/> Relevant & not met <input type="checkbox"/> Not relevant
A5.4 Siting and Design	
A5.4a Asset protection zone (APZ)	Applicable: Yes Compliant: Yes
<p>APZ DIMENSIONS – DIFFERENCES IN REQUIREMENTS FOR PLANNING ASSESSMENTS COMPARED TO IMPLEMENTATION</p> <p>A key required bushfire protection measure is to reduce the exposure of buildings/infrastructure (as exposed vulnerable elements at risk), to the direct bushfire threats of flame contact, radiant heat and embers and the indirect threat of consequential fires that result from the subsequent ignition of other combustible materials that may be constructed, stored or accumulate in the area surrounding these structures. This reduces the associated risks of damage or loss.</p> <p>This is achieved by separating buildings (and consequential fire fuels as necessary) from areas of classified bushfire prone vegetation. This area of separation surrounding buildings is identified as the Asset Protection Zone (APZ) and consists of no vegetation and/or low threat vegetation or vegetation continually managed to a minimal fuel condition. The required separation distances will vary according to the site specific conditions and local government requirements.</p> <p>The APZ dimensions stated and/or illustrated in this Report can vary dependent on the purpose for which they are being identified.</p> <div style="border: 1px solid black; padding: 10px; margin-top: 10px;"> <p><i>Note: Appendix B 'Onsite Vegetation Management' provides further information regarding the different APZ dimensions that can be referenced, their purpose and the specifications of the APZ that are to be established and maintained on the subject lot.</i></p> </div>	

THE 'PLANNING BAL-29' APZ DIMENSIONS

Purpose: To provide evidence of the development or use proposal's ability to achieve minimum vegetation separation distances. To achieve 'acceptable solution' planning approval for this factor, it must be demonstrated that the minimum separation distances corresponding to a maximum level of radiant transfer to a building of 29 kW/m², either exist or can be implemented (with certain exceptions). These separation distances are the 'Planning BAL-29' APZ dimensions.

The 'Planning BAL-29' APZ is not necessarily the size of the APZ that must be physically implemented and maintained by a landowner. Rather, its sole purpose is to identify if an acceptable solution for planning approval can be met.

THE 'REQUIRED' APZ DIMENSIONS

Purpose: Establishes the dimensions of the APZ to be physically implemented by the landowner on their lot: These will be the minimum required separation distances from the subject building(s) to surrounding bushfire prone vegetation (identified by type and associated ground slope). These are established by:

- A. The 'BAL Rating APZ' of the subject building(s) when distances are greater than 'B' below (except when 'B' establishes a maximum distance); or
- B. The 'Local Government' APZ' derived from the Firebreak/Hazard Reduction Notice when distances are greater than 'A' above, other than when a maximum distance is established, in which case this will apply; or
- C. A combination of 'A' and 'B'.

Within this Report/Plan it is the 'Planning BAL-29' APZ that will be identified on maps, diagrams and in tables as necessary – unless otherwise stated.

The 'Required' APZ dimension information will be presented in Appendix B1.1 and on the Property Bushfire Management Statement, when required to be included for a development application.

APZ Width: The proposed (or a future) habitable building(s) on the lot(s) of the proposed development - or an existing building for a proposed change of use – can be (or is) located within the developable portion of the lot and be surrounded by a 'Planning BAL-29' APZ of the required dimensions (measured from any external wall or supporting post or column to the edge of the classified vegetation), that will ensure their exposure to the potential radiant heat impact of a bushfire does not exceed 29 kW/m².

Restriction on Building Location: It has been identified that the current developable portion of a lot(s) provides for a future building location that will result in that building being subject to a BA-40 or BAL-FZ rating. Consequently, it may be considered necessary to impose the condition that a restrictive covenant to the benefit of the local government pursuant to section 129BA of the Transfer of Land Act 1893, is to be placed on the certificate(s) of title of the proposed lot(s) advising of the existence of a restriction on the use of that portion of land (refer to Code F3 of Model Subdivision Conditions Schedule, WAPC June 2021 and Guidelines s5.3.2).

APZ Location: The required dimensions for a 'Planning BAL-29' APZ can be contained solely within the boundaries of the lot(s) on which the proposed (or a future) habitable building(s) - or an existing building(s) for a proposed change of use – is situated.

APZ Location: The required dimensions for a 'Planning BAL-29' APZ can be partly established within the boundaries of the lot(s) on which the proposed (or a future) habitable building(s) - or an existing building(s) for a proposed change of use – is situated. The balance of the APZ would exist on adjoining land that

<p>satisfies the exclusion requirements of AS 3959:2018 cl 2.2.3.2 for non-vegetated areas and/or low threat vegetation and/or vegetation managed in a minimal fuel condition.</p>			
<p>APZ Location: It can be justified that any adjoining (offsite) land forming part of a 'Planning BAL-29' APZ will:</p> <p><input type="checkbox"/> <input type="checkbox"/> <input checked="" type="radio"/> <ul style="list-style-type: none"> • If non-vegetated, remain in this condition in perpetuity; and/or • If vegetated, be low threat vegetation or vegetation managed in a minimal fuel condition in perpetuity. </p>			
<p>APZ Management: The area of land (within each lot boundary), that is to make up the required 'Landowner' APZ dimensions (refer to Appendix B, Part B1), can and will be managed in accordance with the requirements of the Guidelines Schedule 1 'Standards for Asset Protection Zones' (refer to Appendix B).</p> <p><input type="checkbox"/> <input type="checkbox"/> <input checked="" type="radio"/></p>			
<p>Subdivision Staging: There are undeveloped future stages of subdivision, containing bushfire prone vegetation, that have been taken into consideration for their potentially 'temporary' impact on the ability to establish a 'Planning BAL-29 APZ' on adjoining developed lots. A staging plan is developed to manage this.</p> <p><input type="checkbox"/> <input type="checkbox"/> <input checked="" type="radio"/></p>			
<p><input checked="" type="checkbox"/> <input type="checkbox"/> <input type="checkbox"/> Firebreak/Hazard Reduction Notice: Any additional requirements established by the relevant local government's annual notice to install firebreaks and manage fuel loads (issued under s33 of the Bushfires Act 1954), can and will be complied with.</p>			
<p>Supporting Assessment Details: The Shire of Nannup's Firebreak Compliance Notice requires a 20m APZ around all buildings, including:</p> <ul style="list-style-type: none"> • A low fuel zone of twenty metres wide shall be provided immediately surrounding all buildings. This includes the shed and water tank as they are within 6m of the habitable building. <p>Substantial clearing is required to achieve a BAL – 29 rating. It is recommended that the landowner check with the Local Government to determine if this level of clearing of native forest would be supported due to potential erosion and run off onto Chalwell Road, and on environmental grounds.</p>			
A5.5 Vehicular Access			
A5.5a Multiple access routes	Applicable:	Yes	Compliant: No
<input type="checkbox"/> <input checked="" type="checkbox"/> <input type="checkbox"/> Two-way public road access is provided in two different directions to at least two different suitable destinations.			
<input checked="" type="checkbox"/> <input type="checkbox"/> <input type="checkbox"/> The exception to the provision of two-way access applies. Public road vehicular access to a suitable destination is available, and it leads away from the bushfire hazard. Secondary access (including an EAW) cannot be achieved.			
<p>Supporting Assessment Details: Chalwell Road is technically a no-through road, as the link to Mount Leewin Loop Road travels through private property and is a forestry track. Chalwell Road to Nannup via Vasse Highway complies with the technical requirements.</p> <p>The Bushfire Evacuation Plan details the evacuation route to the Nannup Recreation Centre as the primary route. Early evacuation is recommended and closure on Extreme, Catastrophic Fire danger days or if there is a fire in the vicinity.</p>			
A5.5b No-through roads – maximum length	Applicable:	Yes	Compliant: No

<input type="checkbox"/> <input type="checkbox"/> <input checked="" type="radio"/>	<p>The no-through public road for the proposed development is no longer than 200 metres. It is existing and the adjoining classified vegetation (excluding the road reserve) is categorised an Extreme Bushfire Hazard Level (Guidelines, Table 3).</p>
<input type="checkbox"/> <input type="checkbox"/> <input checked="" type="radio"/>	<p>The no-through public road for the proposed development is no longer than 500 metres. It is unavoidable and the adjoining classified vegetation (excluding the road reserve) is categorised a Moderate Bushfire Hazard Level (Guidelines, Table 3).</p>
<input type="checkbox"/> <input checked="" type="checkbox"/> <input type="checkbox"/>	<p>The no-through public road is unavoidable and the adjoining classified vegetation (excluding the road reserve) is categorised a Low Bushfire Hazard Level (Guidelines, Table 3) or is not identified as bushfire prone. Consequently, there is no limit on its length.</p>
<p>Supporting Assessment Details: The vegetation along Chalwell Road is classified as Extreme fire danger, with Forest vegetation on the road reserve. No mitigation works have been carried out along this road. Predominantly vegetation on the broader landscape in the area is Forest vegetation.</p>	
<p>A5.5c Emergency access way – alternative access option</p>	<p>Applicable: Yes Compliant: No</p>
<input checked="" type="checkbox"/> <input type="checkbox"/> <input type="checkbox"/>	<p>A5.5a and A5.5b cannot be achieved.</p>
<input type="checkbox"/> <input checked="" type="checkbox"/> <input type="checkbox"/>	<p>The proposed or existing EAW provides a through connection to a public road.</p>
<input type="checkbox"/> <input type="checkbox"/> <input checked="" type="radio"/>	<p>The proposed or existing EAW is less than 500m in length and will be signposted and gated (remaining unlocked) to the specifications stated in the Guidelines and/or required by the relevant local government.</p>
<input type="checkbox"/> <input type="checkbox"/> <input checked="" type="radio"/>	<p>The technical construction requirements for widths, clearances, capacity, gradients and curves (Guidelines, Table 6. Refer also to Appendix C in this BMP), can and will be complied with.</p>
<p>Supporting Assessment Details: The Public Road and No-through Road do not meet the technical requirements. Whilst an Emergency Access Way could be installed, the egress would be back onto Chalwell Road on a corner, hence does not add value in an emergency situation, however, could be installed if directed by the Local Government. Early evacuation is the primary message for guests.</p>	
<p>A5.5d Public roads - technical requirements</p>	<p>Applicable: Yes Compliant: No</p>
<input type="checkbox"/> <input checked="" type="checkbox"/> <input type="checkbox"/>	<p>The technical construction requirements of vertical clearance and weight capacity (Guidelines, Table 6. Refer also to Appendix C in this BMP), can and will be complied with.</p>
<input type="checkbox"/> <input checked="" type="checkbox"/> <input type="checkbox"/>	<p>All other applicable technical requirements of trafficable width, gradients and curves, are required to be in "accordance with the class of road as specified in the IPWEA Subdivision Guidelines, Liveable Neighbourhoods, Ausroad Standards and/or any applicable standard in the local government area" (Guidelines, Table 6 and sE3.1. Refer also to Appendix C in this BMP).</p> <p>The assessment conducted for the bushfire management plan indicates that it is unlikely that the proposed development can and will comply with the requirements.</p> <p>However, the applicable class of road, the associated technical requirements and subsequent proposal compliance, will need to be confirmed with the relevant local government and/or Main Roads WA.</p>
<input type="checkbox"/> <input checked="" type="checkbox"/> <input type="checkbox"/>	<p>A traversable verge is available adjacent to classified vegetation (Guidelines, E3.1), as recommended.</p>

Supporting Assessment Details: Chalwell Road is classified as a No-through Road.			
A5.5e Private driveways - technical requirements	Applicable:	Yes	Compliant: Yes
<input type="checkbox"/> <input type="checkbox"/> <input checked="" type="radio"/>	The private driveway length is no greater than 70m. No technical requirements need to be met.		
<input checked="" type="checkbox"/> <input type="checkbox"/> <input type="checkbox"/>	The technical construction requirements for widths, clearances, capacity, gradients and curves (Guidelines, Table 6. Refer also to Appendix C in this BMP), can and will be complied with.		
<input type="checkbox"/> <input type="checkbox"/> <input checked="" type="radio"/>	Passing bays can and will be installed every 200m with a minimum length of 20m and a minimum additional trafficable width of 2m.		
<input checked="" type="checkbox"/> <input type="checkbox"/> <input type="checkbox"/>	The turnaround area requirements (Figure 28, Guidelines and within 30m of the habitable building) can and will be complied with.		
Supporting Assessment Details: The technical requirements for the driveway can be met. The landowner will need to check the gradient complies with the technical requirements (Appendix C in this document)			
A5.5f Signage	Applicable:	Yes	Compliant: Yes
<input checked="" type="checkbox"/> <input type="checkbox"/> <input type="checkbox"/>	The required information to inform the actions of those persons onsite in the event of a bushfire will be prominently displayed within the site.		
<input checked="" type="checkbox"/> <input type="checkbox"/> <input type="checkbox"/>	This information will include evacuation routes and distance and the site-specific procedural detail that will be established by the Bushfire Emergency Plan (or Information) that is required to be developed for the proposed use.		
Supporting Assessment Details: The evacuation poster will be displayed within the holiday house.			
A5.6 Provision of Water for Firefighting Purposes			
A5.6a Reticulated supply	Applicable:	No	Compliant: N/A
<input type="checkbox"/> <input type="checkbox"/> <input checked="" type="radio"/>	A reticulated water supply is available to the proposed development. The existing hydrant connection(s) are provided in accordance with the specifications of the relevant water supply authority.		
<input type="checkbox"/> <input type="checkbox"/> <input checked="" type="radio"/>	A reticulated water supply is available to the proposed development. Hydrant connection(s) can and will be provided in accordance with the specifications of the relevant water supply authority.		
Supporting Assessment Details: Not required			
A5.6b Non-reticulated supply	Applicable:	Yes	Compliant: Yes
<input checked="" type="checkbox"/> <input type="checkbox"/> <input type="checkbox"/>	A static water supply (tank) for firefighting purposes will be installed on the lot that is additional to any water supply that is required for drinking and other domestic purposes.		
<input checked="" type="checkbox"/> <input type="checkbox"/> <input type="checkbox"/>	The technical requirements (location, volumes, design, materials, pipes and fittings), as established by the Guidelines (Schedule 2 and E4) and/or the relevant local government, can and will be complied with.		

Supporting Assessment Details: The technical requirements for firefighting water supply can be achieved. The coupling set up and piping will need to be replaced as per Appendix D for the firefighting water supply specifications and technical requirements.

6. RESPONSIBILITIES FOR IMPLEMENTATION AND MANAGEMENT OF THE BUSHFIRE PROTECTION MEASURES

6.1 Developer/Landowner Responsibilities – Prior to Opening

DEVELOPER/LANDOWNER RESPONSIBILITIES – PRIOR TO OPENING	
No.	Implementation Actions
1	Water tank dedicated for firefighting purposes: Establish a 20m APZ around the existing water supply closest to the building. Bury plastic piping, or exchange to metal couplings/piping.
2	Trim trees along the driveway to comply with the Shire of Nannup Firebreak Compliance Notice.
3	Display the Bushfire Evacuation Plan and poster in the Holiday House.
4	Ensure the driveway complies with Appendix C technical requirements. For unsealed roads the requirement is a maximum 10% gradient.
5	Refer to 2.3 BUSHFIRE RISK MANAGEMENT AND ENVIRONMENTAL CONSERVATION of the Guidelines-for-planning-in-bushfire-prone-areas-version-1.4 (link in Appendixes) and discuss with the Local Government in respect to environmental and erosion considerations prior to any undertaking of vegetation clearing. Clearing of native vegetation in Western Australia requires a clearing permit under Part V, Division 2 of the Environmental Protection Act 1986.
6	Create a BAL-29 Asset Protection Zone (APZ) around the residence and around the water tank closest to the house and the shed. Refer to Schedule 1- Standards for Asset Protection Zones (within this document).

6.2 Landowner/Occupier Responsibilities – Ongoing Management

LANDOWNER/OCCUPIER – ONGOING MANAGEMENT	
No.	Management Actions
1	<p>Maintain the Asset Protection Zone (APZ) around buildings, water tanks (and other structures as required) to satisfy:</p> <ul style="list-style-type: none"> The dimension requirements established by the assessed site-specific conditions and the building's determined BAL rating, or the dimensions established by the annually issued local government Firebreak Notice – whichever is greater [refer to Section 5.4 of this BMP – including the notes 'What Sized APZ is to be Installed on the Lot']; and The standards established by the Guidelines DPLH, 2021 v1.4, Schedule 1, or as varied by the local government through their annually issued Firebreak Notice.
2	<p>The subject site is to be compliant with current version of the Shire of Nannup's Fire Break Compliance Notice issued under s33 of the Bushfires Act 1954.</p> <p>This may include specifications for asset protection zones that differ from Schedule 1 in the Guidelines DPLH, 2021 v1.4, with the intent to better satisfy local conditions.</p> <p>[Refer to Section 5.3 and the information presented in Appendix B].</p>
3	<p>As a vulnerable tourism land use for which open air campfires (contained in a firepit) are a part of site operations, enforce the use restrictions established by s25 of the Bush Fires Act 1954 and ensure the required vegetation clearances are maintained.</p>
4	<p>Maintain vehicular access route within the property to comply with the technical requirements referenced in the BMP and the relevant local government annual firebreak notice.</p>
5	<p>Maintain the static firefighting water supply tank and associated pipes/fittings/pump and vehicle hardstand in good working condition.</p>
6	<p>Ensure that builders engaged to construct dwellings/additions and/or other relevant structures on the lot, are aware of the existence of this approved Bushfire Management Plan (BMP). The plan identifies that the development site is within a designated bushfire prone area and states the indicative (or determined) BAL rating(s) that may (or will) be applied to buildings/structures. A BAL assessment report may be required to confirm determined ratings and will be required when ratings are indicative. BAL certificates will need to be issued to accompany building applications.</p> <p>The BMP may also establish, as an additional bushfire protection measure, that construction requirements to be applied will be those corresponding to a specified higher BAL rating.</p> <p>Compliance with the Building Code of Australia (Volumes 1 and 2 of the National Construction Code), will require certain bushfire resistant construction requirements be applied to residential buildings in bushfire prone areas (i.e., Class 1, 2 and 3 and associated Class 10a buildings and decks). Other classes of buildings may also be required to comply with the construction when established by the relevant authority or if identified as an additional bushfire protection measure within the BMP.</p> <p>The deemed to satisfy solutions that will meet the relevant bushfire performance requirements are found in AS 3959 – Construction of Building in Bushfire Prone Areas (as amended) and the NASH Standard – Steel Framed Construction in Bushfire Areas (as amended).</p>

7	<p>Ensure all future buildings the landowner/lessee has responsibility for, are designed and constructed in full compliance with:</p> <ul style="list-style-type: none">• The bushfire resistant construction requirements of the Building Code of Australia (Volumes 1 and 2 of the National Construction Code), as established by the Building Regulations 2012 (WA Building Act 2011); and <p>Any additional bushfire protection measures this Bushfire Management Plan has established are to be implemented.</p>
---	-------------------------------------------------------------------------------------------------------------------------------------------------------------------------------------------------------------------------------------------------------------------------------------------------------------------------------------------------------------------------------------------------------------------------------------------------------------------------------------------------------------------------------------

6.3 Local Government –Ongoing Management

LOCAL GOVERNMENT – PRIOR TO OCCUPANCY AND ONGOING MANAGEMENT	
No.	Management Actions
1	<p>Monitor landowner compliance with the annual Shire of Nannup's Fire Break Compliance Notice and with any bushfire protection measures that are:</p> <ul style="list-style-type: none"> • Established by this BMP; • Are required to be maintained by the landowner/occupier; and • Are relevant to local government operations.

APPENDIX A: SUBJECT SITE BAL ASSESSMENT INFORMATION AND ADDITIONAL DATA

Assessed Site Inputs Common to the Method 1 and Method 2 Procedures

A1.1: FIRE DANGER INDICES (FDI/FDI/GFDI)

When using Method 1 the relevant FDI value required to be applied for each state and region is established by AS 3959:2018, Table 2.1. Each FDI value applied in Tables 2.4 – 2.7 represents both the Forest Fire Danger Index (FFDI) and a deemed equivalent for the Grassland Fire Danger Index (GFDI), as per Table B2 in Appendix B. When using Method 2, the relevant FFDI and GFDI are applied.

The values may be able to be refined within a jurisdiction, where sufficient climatological data is available and in consultation with the relevant authority.

Relevant Jurisdiction:	WA	Region:	Whole State	Method 1	Applied FDI:	80
				Method 2	Applied FFDI:	N/A
					Applied GFDI:	N/A

Site Assessment Details - Explanation & Justification: Method 2 FFDI is to be applied to the scrub areas of vegetation to calculate the required 10kW/m² low threat zone for the on-site shelter building.

A1.2: VEGETATION ASSESSMENT AND CLASSIFICATION

Vegetation Types and Classification

In accordance with AS 3959:2018 clauses 2.2.3 and C2.2.3.1, all vegetation types within 100 metres of the 'site' (defined as "the part of the allotment of land on which a building stands or is to be erected"), are identified and classified. Any vegetation more than 100 metres from the site that has influenced the classification of vegetation within 100 metres of the site, is identified and noted. The maximum excess distance is established by AS 3959: 2018 cl 2.2.3.2 and is an additional 100 metres.

Classification is also guided by the Visual Guide for Bushfire Risk Assessment in WA (WA Department of Planning February 2016) and any relevant FPA Australia practice notes.

Modified Vegetation

The vegetation types have been assessed as they will be in their natural mature states, rather than what might be observed on the day. Vegetation destroyed or damaged by a bushfire or other natural disaster has been assessed on its expected re-generated mature state. Modified areas of vegetation can be excluded from classification if maintained in a permanently low threat, minimal fuel condition, satisfying AS 3959:2018 s2.2.3.2(f), and there is sufficient justification to reasonable expect that this modified state will exist in perpetuity.

The Influence of Ground Slope

Where significant variation in effective slope exists under a consistent vegetation type, these will be delineated as separate vegetation areas to account for the difference in potential bushfire behaviour, in accordance with AS 3959:2018 clauses 2.2.5 and C2.2.5.

THE INFLUENCE OF VEGETATION GREATER THAN 100 METRES FROM THE SUBJECT SITE

Vegetation area(s) within 100m of the site whose classification has been influenced by the existence of bushfire prone vegetation from 100m – 200m from the site:

No





VEGETATION AREA 1						
Classification	A. FOREST					
Types Identified	Tall open forest A-01					
Exclusion Clause	N/A					
Effective Slope	Measured	flat 0 degrees	Applied Range (Method 1)	Upslope or flat 0 degrees		
Foliage Cover (all layers)	>90%	Shrub/Heath Height	Up to 6m	Tree Height	Up to 30m	
Dominant & Sub-Dominant Layers (species as relevant)	Eucalypt (Marri, Jarrah) trees to a height of 25m, foliage cover 90%. Around the carpark there are native bushes planted, along with Eucalypt saplings.					
Understorey:	Leaf litter, native grasses and bushes, saplings, Acacia, Tea Tree, Peppermints, Xanthoria					
Additional Justification:	Not Required.					
Post Development Assumptions:	Onsite vegetation can be managed to achieve an APZ around buildings					
						
PHOTO ID: 1			PHOTO ID: 2			
						
PHOTO ID: 3			PHOTO ID: 4			



PHOTO ID: 5



PHOTO ID: 6

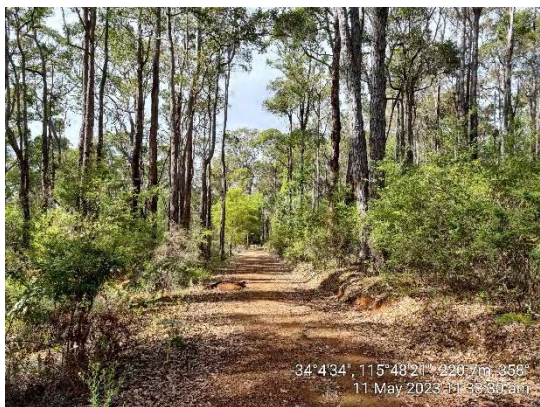



PHOTO ID: 7



PHOTO ID: 8

VEGETATION AREA 2					
Classification	G. GRASSLAND				
Types Identified	Sown pasture G-26				
Exclusion Clause	N/A				
Effective Slope	Measured	flat 0 degrees	Applied Range (Method 1)	Upslope or flat 0 degrees	
Foliage Cover (all layers)	-	Shrub/Heath Height	-	Tree Height	-
Dominant & Sub-Dominant Layers (species as relevant)	To the west of the development site the neighbouring property is cleared and sown pasture is managed by horses. The grass height is currently less than 10cms.				
Understorey:	Not applicable				
Additional Justification:	Not required.				
Post Development Assumptions:	Vegetation is offsite and cannot be managed or removed by the landowner.				
 <p>34°4'33", 115°48'17", 215.3m, 303° 11 May 2023 11:09:24 am</p>			 <p>34°4'34", 115°48'17", 220.3m, 294° 11 May 2023 11:10:06 am</p>		
PHOTO ID: 9			PHOTO ID: 10		









VEGETATION AREA 3					
Classification	A. FOREST				
Types Identified	Tall open forest A-01		Pine plantation		
Exclusion Clause	N/A				
Effective Slope	Measured	d/slope 14.6 degrees	Applied Range (Method 1)		Downslope >10-15 degrees
Foliage Cover (all layers)	>90%	Shrub/Heath Height	Up to 6m	Tree Height	Up to 30m
Dominant & Sub-Dominant Layers (species as relevant)	On the northern side of Chalwell Road is a pine plantation with vegetation to 20m tall with 80% vegetation cover. Between the existing building and Chalwell Road the dominant vegetation is primarily Eucalypt (Marri and Jarrah) trees growing to a height of 25m with 90% vegetation cover.				
Understorey:	Bracken, Xanthoria, Acacia, Tea Tree, fallen logs, native bushes and grasses, and leaf litter.				
Additional Justification:	Not required.				
Post Development Assumptions:	Onsite vegetation can be managed to create an APZ around buildings				
					
PHOTO ID: 11			PHOTO ID: 12		
					
PHOTO ID: 13			PHOTO ID: 14		







PHOTO ID: 15



PHOTO ID: 16

VEGETATION AREA 4					
Classification	A. FOREST				
Types Identified	Tall open forest A-01				
Exclusion Clause	N/A				
Effective Slope	Measured	d/slope 3.2 degrees	Applied Range (Method 1)	Downslope >0-5 degrees	
Foliage Cover (all layers)	>90%	Shrub/Heath Height	Up to 6m	Tree Height	Up to 30m
Dominant & Sub-Dominant Layers (species as relevant)	The dominant vegetation is primarily Eucalypt (Marri and Jarrah) trees growing to a height of 25m with 90% vegetation cover. Much of the vegetation within this area is regrowth.				
Understorey:	Bracken, Xanthoria, Acacia, Tea Tree, fallen logs, native bushes and grasses, and leaf litter.				
Additional Justification:	Not required.				
Post Development Assumptions:	Onsite vegetation can be managed to create an APZ around buildings				
					
PHOTO ID: 17			PHOTO ID: 18		
					
PHOTO ID: 19			PHOTO ID: 20		

VEGETATION AREA 5					
Classification	EXCLUDED				
Types Identified					
Exclusion Clause	2.2.3.2 (e) non-vegetated areas and (f) low threat vegetation - high moisture content.				
Effective Slope	Measured	-	Applied Range (Method 1)	-	
Foliage Cover (all layers)	-	Shrub/Heath Height	-	Tree Height	-
Dominant & Sub-Dominant Layers (species as relevant)	Immediately surrounding the residence is managed gardens, carpark and driveway. Other excluded areas include the road network and dam. On the neighbouring property there is a horse arena that is not vegetated.				
Understorey:	Not applicable				
Additional Justification:	It is assumed that these areas will be maintained in perpetuity.				
Post Development Assumptions:	Not required				
 <p>34°4'32", 115°48'19", 218.8m, 341° 11 May 2023 11:36:17 am</p>			 <p>34°4'32", 115°48'20", 285.5m, 332° 11 May 2023 11:00:05 am</p>		
PHOTO ID: 21			PHOTO ID: 22		
 <p>34°4'33", 115°48'20", 229.7m, 340° 11 May 2023 11:00:27 am</p>			 <p>34°4'34", 115°48'23", 220.5m, 310° 11 May 2023 11:34:35 am</p>		
PHOTO ID: 23			PHOTO ID: 24		

A1.3: SEPARATION DISTANCE

Measuring

The separation distance is the distance in the horizontal plane between the receiver (building/structure or area of land being considered) and the edge of the classified vegetation (AS 3959:2018, clause 2.2.4)

The relevant parts of a building/structure from which the measurement is taken is the nearest part of an external wall or where a wall does not exist, the supporting posts or columns. Certain parts of buildings are excluded including eaves and roof overhangs.

The edge of the vegetation, for forests and woodlands, will be determined by the unmanaged understorey rather than either the canopy (drip line) or the trunk (AS 3959:2018, clause C2.2.5).

Measured Separation Distance as a Calculation Input

If a separation distance can be measured because the location of the building/structure relative to the edge of the relevant classified vegetation is known, this figure can be entered into the BAL calculation. The result is a determined BAL rating.

Assumed Separation Distance as a Calculation Input

When the building/structure location within the lot is not known, an assumed building location may be applied that would establish the closest positioning of the building/structure relative to the relevant area of vegetation.

The assumed location would be based on a factor that puts a restriction on a building location such as:

- An established setback from the boundary of a lot, such as a residential design code setback or a restrictive covenant; or
- Within an established building envelope.

The resultant BAL rating would be indicative and require later confirmation of the building/structure actual location relative to the vegetation to establish the determined BAL rating.

Separation Distance as a Calculation Output

With the necessary site specific assessment inputs and using the AS 3959:2018 bushfire modelling equations, the range of separation distances that will correspond to each BAL rating (each of which represents a range of radiant heat flux), can be calculated.

This has application for bushfire planning scenarios such as:

- When the separation distance cannot be measured because the exact location of the exposed element (i.e., the building, structure or area), relative to classified vegetation, is yet to be determined.

In this scenario, the required information is the identification of building locations onsite that will correspond to each BAL rating. That is, indicative BAL ratings can be derived for a variety of potential building/structure locations; or

- The separation distance is known for a given building, structure or area (and a determined BAL rating can be derived), but additional information is required regarding the exposure levels (to the transfer of radiant heat from a bushfire), of buildings or persons, that will exist at different points within the subject site.

The calculated range of separation distances corresponding to each BAL rating can be presented in a table and/or illustrated as a BAL Contour Map – whichever is determined to best fit the purpose of the assessment.

For additional information refer to the information boxes in Section 3 'Bushfire Attack Levels (BAL) - Understanding the Results and Section 3.2. 'Interpretation of the BAL Contour Map'.

SITE ASSESSMENT DETAILS - EXPLANATION & JUSTIFICATION

For the subject development/use the applicable separation distances values are derived from calculations applying the assessed site data. They are an output value, not an input value and therefore are not presented or justified in this appendix.

The derived values are presented in Section 3, Table 3.1.

APPENDIX B: ONSITE VEGETATION MANAGEMENT - THE APZ

THE ASSET PROTECTION ZONE (APZ)

This is an area surrounding a habitable building containing either no fire fuels and/or low threat fire fuels that are maintained in a minimal fuel condition. The primary objectives include:

- To ensure the building is sufficiently separated from the bushfire hazard to limit the impact of its direct attack mechanisms. That is, the dimensions of the APZ will, for most site scenarios, remove the potential for direct flame contact on the building, reduce the level of radiant heat to which the building is exposed and ensure some reduction in the level of ember attack (with the level of reduction being dependent on the vegetation types of present);
- To ensure any vegetation retained within the APZ presents low threat levels and prevents surface fire spreading to the building;
- To ensure other combustible materials that can result in consequential fire (typically ignited by embers) within both the APZ and parts of the building, are eliminated, minimised and/or appropriately located or protected. The explanatory notes in the Guidelines provide some guidance for achieving this objective and other sources are available. This is a primary cause of building loss in past bushfire events; and
- Provide a defensible space for firefighting activities.

B1: The Dimensions and Location of the APZ to be Established and Maintained

THE APZ DIMENSIONS

The determined BAL rating of the relevant building/structure will establish the corresponding bushfire construction requirements that are to apply. The minimum required APZ dimensions must be those that will ensure the retention of the determined BAL rating. This ensures that the potential radiant heat exposure of the building/structure will be limited to the level that the applied construction requirements are designed to resist.

The size of the APZ that is to be established and maintained surrounding the subject building/structure, will be the largest that is defined by either:

- The dimensions corresponding to the determined BAL rating stated on the BAL Certificate and which accounts for the specific site conditions; or
- The dimensions established by the relevant local government's annual firebreak notice as can be issued under s33 of the Bushfires Act 1954. This may state a required single minimum dimension for an APZ surrounding a building, or a dimension that varies with slope of the land under the different areas of bushfire prone vegetation that impact the building. Check the notice annually for revisions to requirements.

Relevant Buildings(s)	Classified Vegetation [refer Fig 3.1]	Minimum Required Separation Distances (m)					Stated in the Relevant Firebreak Notice
		Corresponding to Stated BAL					
		BAL-29	BAL-19	BAL-12.5	BAL-LOW		
Existing building	Forest	21m	31m	42m	100m	20	
	Grassland	8m	12m	17m	50m	20	
	Forest	42m	56m	73m	100m	20	
	Forest	27m	37m	50m	100m	20	
Shed	Forest	-	-	-	-	20	
Water Tank	Forest	-	-	-	-	20	

THE APZ LOCATION

The APZ should be contained solely within the boundaries of the lot, except in instances where the neighbouring lot(s) or adjacent public land is non-vegetated or will be maintained to a low-fuel state in perpetuity, and this can be justified. Where possible, planning for siting and design of development should incorporate elements that include non-vegetated areas (e.g., roads / parking / drainage / water body) and/or formally managed areas of vegetation (public open space / recreation areas / services installed in a common section of land), as either part of the required APZ dimensions for each lot or to additionally increase separation distances to reduce exposure further.

B2: The Standards for the APZ as Established by the Guidelines (DPLH, v1.4)

Within the Guidelines (source: <https://www.wa.gov.au/government/document-collections/state-planning-policy-37-planning-bushfire-prone-areas>), the management Standards are established by:

- Schedule 1: Standards for Asset Protection Zones (see extract below) established by the Guidelines; and
- The associated explanatory notes (Guidelines E2) that address (a) managing an asset protection zone (APZ) to a low threat state (b) landscaping and design of an asset protection zone and (c) plant flammability.

Guidelines for
Planning in
Bushfire
Prone Areas

71

ELEMENT 2: SITING AND DESIGN OF DEVELOPMENT

SCHEDULE 1: STANDARDS FOR ASSET PROTECTION ZONES

OBJECT	REQUIREMENT
Fences within the APZ	<ul style="list-style-type: none"> • Should be constructed from non-combustible materials (for example, iron, brick, limestone, metal post and wire, or bushfire-resisting timber referenced in Appendix F of AS 3959).
Fine fuel load (Combustible, dead vegetation matter <6 millimetres in thickness)	<ul style="list-style-type: none"> • Should be managed and removed on a regular basis to maintain a low threat state. • Should be maintained at <2 tonnes per hectare (on average). • Mulches should be non-combustible such as stone, gravel or crushed mineral earth or wood mulch >6 millimetres in thickness.
Trees* (>6 metres in height)	<ul style="list-style-type: none"> • Trunks at maturity should be a minimum distance of six metres from all elevations of the building. • Branches at maturity should not touch or overhang a building or powerline. • Lower branches and loose bark should be removed to a height of two metres above the ground and/or surface vegetation. • Canopy cover within the APZ should be <15 per cent of the total APZ area. • Tree canopies at maturity should be at least five metres apart to avoid forming a continuous canopy. Stands of existing mature trees with interlocking canopies may be treated as an individual canopy provided that the total canopy cover within the APZ will not exceed 15 per cent and are not connected to the tree canopy outside the APZ.

Figure 19: Tree canopy cover – ranging from 15 to 70 per cent at maturity

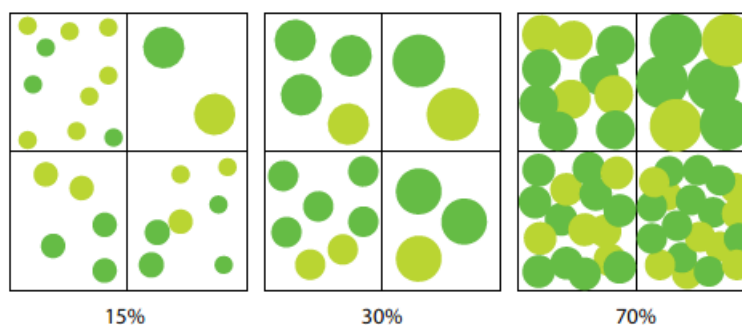

<p>Shrub* and scrub* (0.5 metres to six metres in height). Shrub and scrub >6 metres in height are to be treated as trees.</p>	<ul style="list-style-type: none"> • Should not be located under trees or within three metres of buildings. • Should not be planted in clumps >5 square metres in area. • Clumps should be separated from each other and any exposed window or door by at least 10 metres.
<p>Ground covers* (<0.5 metres in height. Ground covers >0.5 metres in height are to be treated as shrubs)</p>	<ul style="list-style-type: none"> • Can be planted under trees but must be maintained to remove dead plant material, as prescribed in 'Fine fuel load' above. • Can be located within two metres of a structure, but three metres from windows or doors if >100 millimetres in height.
<p>Grass</p>	<ul style="list-style-type: none"> • Grass should be maintained at a height of 100 millimetres or less, at all times. • Wherever possible, perennial grasses should be used and well-hydrated with regular application of wetting agents and efficient irrigation.
<p>Defendable space</p>	<ul style="list-style-type: none"> • Within three metres of each wall or supporting post of a habitable building, the area is kept free from vegetation, but can include ground covers, grass and non-combustible mulches as prescribed above.
<p>LP Gas Cylinders</p>	<ul style="list-style-type: none"> • Should be located on the side of a building furthest from the likely direction of a bushfire or on the side of a building where surrounding classified vegetation is upslope, at least one metre from vulnerable parts of a building. • The pressure relief valve should point away from the house. • No flammable material within six metres from the front of the valve. • Must sit on a firm, level and non-combustible base and be secured to a solid structure.

* Plant flammability, landscaping design and maintenance should be considered – refer to explanatory notes

B3: The Standards for the APZ as Established by the Local Government

Refer to the Firebreak Notice issued annually (under s33 of the Bushfires Act 1954) by the relevant local government. It may state Standards that vary from those established by the Guidelines and that have been endorsed by the WAPC and DFES as per Section 4.5.3 of the Guidelines.

A copy of the relevant annual notice is not included here as they are subject to being reviewed and modified prior to issuing each year. Refer to ratepayers notices and/or the local government's website for the current version.

B4: Maintaining Low Threat and Non-Vegetated Areas Excluded from Classification

AS 3959 establishes the methodology for determining a bushfire attack level (BAL). The methodology includes the classification of the subject site's surrounding vegetation according to their 'type' and the application of the corresponding bushfire behaviour models to determine the BAL. Certain vegetation can be considered as low threat and excluded from classification. Where this has occurred in assessing the site, the extract from AS3959:2018 below state the requirements (including the size of the vegetation area if relevant to the assessment) for maintenance of those areas of land.

15

AS 3959:2018

2.2.3.2 Exclusions—Low threat vegetation and non-vegetated areas

The following vegetation shall be excluded from a BAL assessment:

- (a) Vegetation of any type that is more than 100 m from the site.
- (b) Single areas of vegetation less than 1 ha in area and not within 100 m of other areas of vegetation being classified vegetation.
- (c) Multiple areas of vegetation less than 0.25 ha in area and not within 20 m of the site, or each other or of other areas of vegetation being classified vegetation.
- (d) Strips of vegetation less than 20 m in width (measured perpendicular to the elevation exposed to the strip of vegetation) regardless of length and not within 20 m of the site or each other, or other areas of vegetation being classified vegetation.
- (e) Non-vegetated areas, that is, areas permanently cleared of vegetation, including waterways, exposed beaches, roads, footpaths, buildings and rocky outcrops.
- (f) Vegetation regarded as low threat due to factors such as flammability, moisture content or fuel load. This includes grassland managed in a minimal fuel condition, mangroves and other saline wetlands, maintained lawns, golf courses (such as playing areas and fairways), maintained public reserves and parklands, sporting fields, vineyards, orchards, banana plantations, market gardens (and other non-curing crops), cultivated gardens, commercial nurseries, nature strips and windbreaks.

NOTES:

- 1 Minimal fuel condition means there is insufficient fuel available to significantly increase the severity of the bushfire attack (recognizable as short-cropped grass for example, to a nominal height of 100 mm).
- 2 A windbreak is considered a single row of trees used as a screen or to reduce the effect of wind on the leeward side of the trees.

APPENDIX C: TECHNICAL REQUIREMENTS FOR VEHICULAR ACCESS

The design/layout requirements for access are established by the acceptable solutions of the Guidelines (DPLH, 2021 v1.4) Element 3 and vary dependent on the access component, the land use and the presence of 'vulnerable' persons. Consequently, the best reference source are the Guidelines. The technical requirements that are fixed for all components and uses are presented in this appendix.

GUIDELINES TABLE 6, EXPLANATORY NOTES E3.3 & E3.6 AND RELEVANT ACCEPTABLE SOLUTIONS

Technical Component	Vehicular Access Types / Components			
	Public Roads	Emergency Access Way ¹	Fire Service Access Route ¹	Battle-axe and Private Driveways ²
Minimum trafficable surface (m)	In accordance with A3.1	6	6	4
Minimum Horizontal clearance (m)	N/A	6	6	6
Minimum Vertical clearance (m)	4.5			
Minimum weight capacity (t)	15			
Maximum Grade Unsealed Road ³	As outlined in the IPWEA Subdivision Guidelines	1:10 (10%)		
Maximum Grade Sealed Road ³		1:7 (14.3%)		
Maximum Average Grade Sealed Road		1:10 (10%)		
Minimum Inner Radius of Road Curves (m)		8.5		

Turnaround Area Dimensions for No-through Road, Battle-axe Legs and Private Driveways ⁴

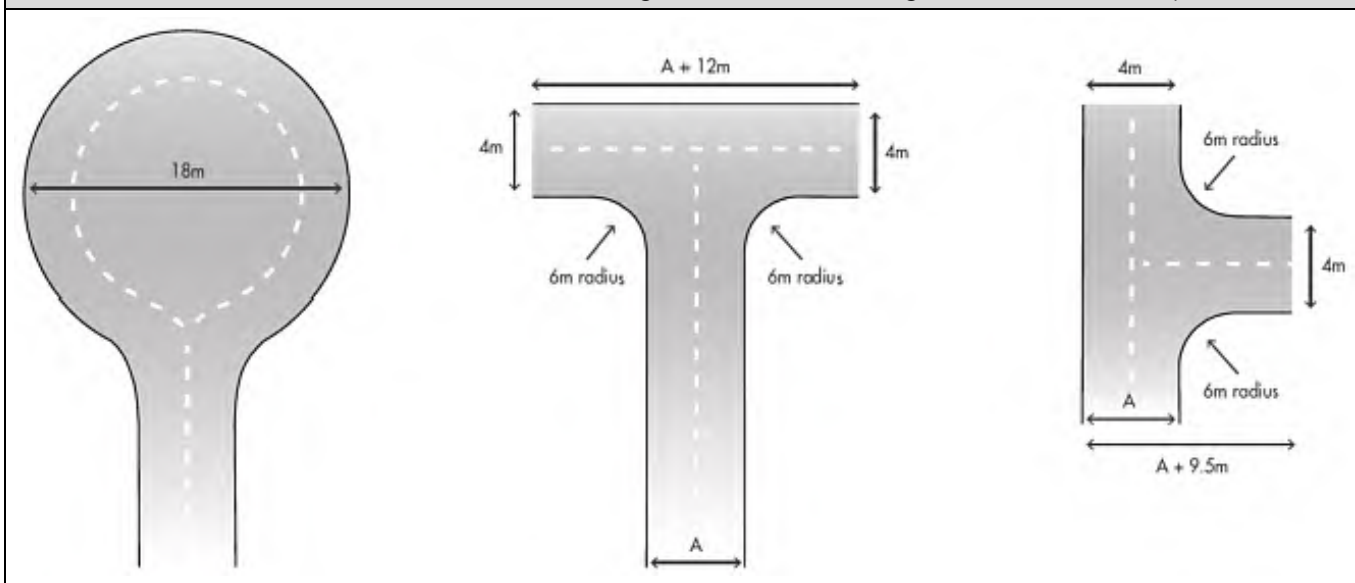

Passing Bay Requirements for Battle-axe leg and Private Driveway

When the access component length is greater than the stated maximum, passing bays are required every 200m with a minimum length of 20m and a minimum additional trafficable width of 2m (i.e. the combined trafficable width of the passing bay and constructed private driveway to be a minimum 6m).

Emergency Access Way – Additional Requirements

Provide a through connection to a public road, be no more than 500m in length, must be signposted and if gated, gates must be open the whole trafficable width and remain unlocked.

¹ To have crossfalls between 3 and 6%.

² Where driveways and battle-axe legs are not required to comply with the widths in A3.5 or A3.6, they are to comply with the Residential Design Codes and Development Control Policy 2.2 Residential Subdivision.

³ Dips must have no more than a 1 in 8 (12.5% or 7.1 degree) entry and exit angle.

⁴ The turnaround area should be within 30m of the main habitable building.

APPENDIX D: TECHNICAL REQUIREMENTS FOR FIREFIGHTING WATER SUPPLY

D2: Non-Reticulated Areas – Static Supply

For specified requirements, refer to the Guidelines Element 4: Water – Acceptable Solution A4.2, Explanatory Notes E4 (that provide water supply establishment detail under the headings of water supply; independent water and power supply; strategic water supplies, alternative water sources and location of water tanks) and the technical requirements established by Schedule 2 (reproduced below).

SCHEDULE 2: WATER SUPPLY DEDICATED FOR BUSHFIRE FIREFIGHTING PURPOSES

2.1 Water supply requirements

Water dedicated for firefighting should be provided in accordance with Table 7 below, and be in addition to water required for drinking purposes.

Table 7: Water supply dedicated for bushfire firefighting purposes

PLANNING APPLICATION	NON-RETICULATED AREAS
Development application	10,000L per habitable building
Structure Plan / Subdivision: Creation of 1 additional lot	10,000L per lot
Structure Plan / Subdivision: Creation of 3 to 24 lots	10,000L tank per lot or 50,000L strategic water tank
Structure Plan / Subdivision: Creation of 25 lots or more	50,000L per 25 lots or part thereof Provided as a strategic water tank(s) or 10,000L tank per lot

2.2 Technical requirements

2.2.1 Construction and design

An above-ground tank and associated stand should be constructed of non-combustible material. The tank may need to comply with AS/NZS 3500.1:2018.

Below ground tanks should have a 200mm diameter access hole to allow tankers or emergency service vehicles to refill direct from the tank, with the outlet location clearly marked at the surface. The tank may need to comply with AS/NZS 3500.1:2018. An inspection opening may double as the access hole provided that the inspection opening meets the requirements of AS/NZS 3500.1:2018. If the tank is required under the BCA as part of fire hydrant installation, then the tank will also need to comply with AS 2419.

Where an outlet for an emergency service vehicle is provided, then an unobstructed, hardened ground surface is to be supplied within four metres of any water supply.

2.2.2 Pipes and fittings

All above-ground, exposed water supply pipes and fittings should be metal. Fittings should be located away from the source of bushfire attack and be in accordance with the applicable section below, unless otherwise specified by the local government.

2.2.2.1 Fittings for above-ground water tanks:

- Commercial land uses: 125mm Storz fitting; or
- Strategic water tanks: 50mm or 100mm (where applicable and adapters are available) male camlock coupling with full flow valve; or
- Standalone water tanks: 50mm male camlock coupling with full flow valve; or
- Combined water tanks: 50mm male camlock coupling with full flow valve or a domestic fitting, being a standard household tap that enables an occupant to access the water supply with domestic hoses or buckets for extinguishing minor fires.

2.2.2.2 Remote outlets

In certain circumstances, it may be beneficial to have the outlet located away from the water supply. In such instances in which a remote outlet is to be used, the applicant should consult the local government and DFES on their proposal.

EXAMPLE CONSTRUCTION AND FITTINGS



Strategic 47,000 Litre Concrete Tank & Protected Fittings



10,000 Litre Concrete Tank



Storz and Camlock Couplings



Full Flow 50mm Ball Valve



Full Flow 50mm Gate Valve and Male Camlock



Bushfire Emergency Plan

An Information Document for Premises Without Onsite Personnel Responsible for Emergency Management

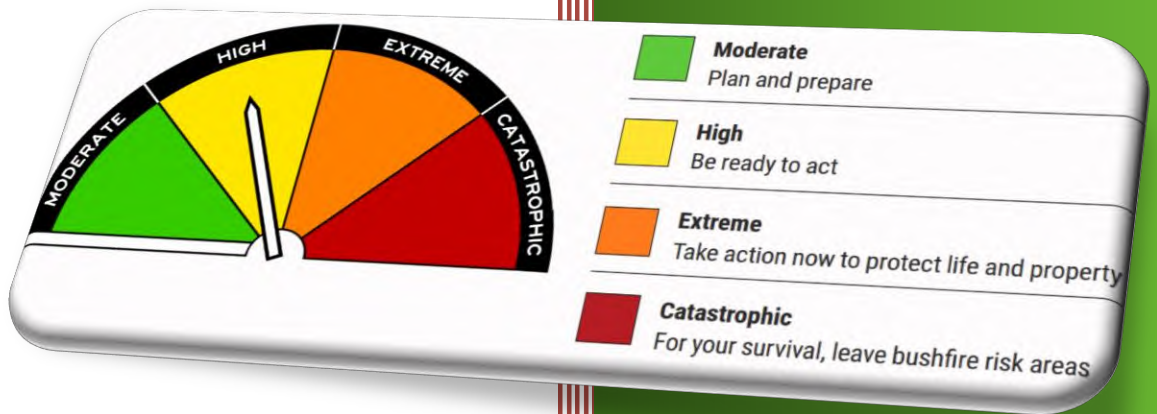

PREVENT | PREPARE | RESPOND

314 Chalwell Road, Carlotta

Shire of Nannup

Facility/Premises Use: Holiday accommodation

5 June 2023

Associated BMP:

BPP Ref. No. 230256

BPP GROUP PTY LTD T/A BUSHFIRE PRONE PLANNING

ACN: 39 166 551 784 | ABN: 39 166 551 784

**LEVEL 1, 159-161 JAMES STREET
GUILDFORD WA 6055**

**PO BOX 388
GUILDFORD WA 6935**

08 6477 1144 | admin@bushfireprone.com.au



DOCUMENT CONTROL



PREPARATION					
Author:	Kathy Nastov (BPAD Level 3 No. 27794)				
Co-Author:	Louise Stokes (BPAD Level 1 No. 51589)				
VERSION HISTORY					
Version	Details			Date	
1.0	Original			5 July 2023	
-	-				
BEP Template (Unsupervised Site) v9.2					
DISTRIBUTION					
Destination		Version	No. Copies	Hard Copy	Electronic Copy
Person	Email				
Christine Donnelly		1.0	1	<input type="checkbox"/>	<input checked="" type="checkbox"/>
<p>Limitation of Liability: The procedures and their associated actions contained in this Bushfire Emergency Plan do not guarantee that, in the event of a bushfire, buildings or infrastructure will not be damaged, persons injured, or fatalities occur either on the subject site or off the site while evacuating. This is substantially due to the unpredictable nature and behaviour of fire and fire weather conditions. Additionally, the correct implementation of the required procedures will depend upon, among other things, the ongoing actions of the landowners and/or operators over which Bushfire Prone Planning has no control.</p> <p>Any representation, statement, opinion, or advice expressed or implied in this document is made in good faith based on information available to Bushfire Prone Planning at the time. Bushfire Prone Planning will not, except as the law may require, be liable for any loss or other consequences whether or not due to the negligence, lack of care or otherwise of their consultants, their servants or agents, arising out of the services provided by their consultants.</p> <p>Copyright ©2022 BPP Group Pty Ltd: All intellectual property rights, including copyright, in format and proprietary content contained in documents created by Bushfire Prone Planning, remain the property of BPP Group Pty Ltd. Any use made of such format or content without the prior written approval of Bushfire Prone Planning, will constitute an infringement on the rights of the Company which reserves all legal rights and remedies in respect of any such infringement.</p>					

TABLE OF CONTENTS

1. STEPS FOR USING THE BUSHFIRE EMERGENCY PLAN	3
2. EMERGENCY CONTACTS	4
2.1. EMERGENCY SERVICES.....	4
2.2. UTILITIES / MEDICAL / ASSISTANCE.....	4
3. EMERGENCY INFORMATION SOURCES – USE TO INFORM DECISION MAKING	5
4. THE BUSHFIRE EMERGENCY PROCEDURES AND ACTIONS	6
4.1. PREVENT AND PREPARE PROCEDURES – NO BUSHFIRE EXISTS	6
5.1.1 PRE-SEASON PREPARE.....	6
4.1.2 MAINTENANCE	10
4.2. RESPONSE PROCEDURES – BUSHFIRE EXISTS.....	11
5. DISPLAY POSTER – BUSHFIRE EMERGENCY INFORMATION	13
5.1. THE SAFE (EARLY) EVACUATION PROCEDURE.....	14
A. AN ‘ADVICE,’ ‘WATCH AND ACT’ OR ‘EMERGENCY WARNING’ ALERT HAS BEEN ISSUED BY AN EMERGENCY SERVICE AUTHORITY.....	14
B. A BUSHFIRE HAS BEEN IDENTIFIED NEAR YOUR LOCATION. YOU ARE CONCERNED FOR YOUR SAFETY.	14
5.2 THE SHELTER-IN-PLACE PROCEDURE	15

LIST OF ADDITIONAL INFORMATION

APPENDIX 1: BUSHFIRE WARNINGS – WHEN A BUSHFIRE IS IDENTIFIED	16
APPENDIX 2: FIRE DANGER RATINGS - FORECAST BUSHFIRE RISK	17
APPENDIX 3: BUSHFIRE RISKS AND DANGERS	18
APPENDIX 4: GUIDELINES FOR TRAVELLING IN CARS DURING A BUSHFIRE	19
APPENDIX 5: INDICATIVE BUSHFIRE BEHAVIOUR TO IMPACT THE FACILITY/PREMISES.....	20
APPENDIX 6: LANDSCAPING DESIGN & CONSTRUCTION PRINCIPLES TO APPLY.....	24

1. STEPS FOR USING THE BUSHFIRE EMERGENCY PLAN

This Bushfire Emergency Plan (BEP) is an information document whose intent is to appropriately inform two independent types of persons who will be associated with the premise. These persons requiring bushfire emergency management information relevant to their situation are:

1. The owner and/or operator of the premises, who, in most case, will not reside or work on the site and will have no responsibility for actively managing the safety of occupants during a bushfire emergency event; and
2. Those persons who will typically be short stay occupants of the premises.

FOR THE OWNER/OPERATOR: This BEP provides the 'prevention' and 'preparation' procedures and the associated actions that must be conducted and maintained prior to and during the bushfire season. Additional reference information is included as appendices.

FOR THE OCCUPANTS: This BEP provides the 'Bushfire Emergency Information Poster' that will be displayed within the premises to inform the occupants, in the event of a bushfire emergency, of the appropriate 'response' procedures for a given scenario, the associated actions that need to be conducted and identifies the designated evacuation destinations.

Note: When necessary, the specific site/use data and consultant considerations applied in developing the BEP are included as an addendum to explain and justify (support) the actions established by this BEP.

STEP	THE ACTIONS - OWNER/OPERATOR	PAGE
1	Be aware of all content in this Bushfire Emergency Plan.	All Pages
2	Prior to and during the bushfire season (October to April) conduct the Pre-Season Prepare and Maintenance procedures.	6

2. EMERGENCY CONTACTS

2.1. EMERGENCY SERVICES

AGENCY/AUTHORITY	SERVICES	CONTACT
Department of Fire and Emergency Services / Police / Ambulance	Will respond to life threatening emergencies. Use to report a fire.	Phone call: triple zero '000' Phone app: EMERGENCY PLUS
State Emergency Service (SES)	Emergency assistance - securing your property, rescuing persons.	13 2500

2.2. UTILITIES / MEDICAL / ASSISTANCE

AGENCY/ORGANISATION	SERVICES	CONTACT
Nannup Hospital	Emergency medical services	(08) 9756 3800
Manjimup Hospital	Emergency medical services	(08) 9772 5100
Western Power	Response to electricity supply outages and damage.	13 1351
Crisis Care	Crisis accommodation	1800 199 008
Australian Red Cross	Humanitarian assistance	1800 733 276 Website: redcross.org.au/emergencies
Salvation Army	Social services care	13 72 58 (13 SALVOS) Website: salvationarmy.org.au/need-help/disasters-and-emergencies/



3. EMERGENCY INFORMATION SOURCES – USE TO INFORM DECISION MAKING

IMPORTANT - AWARENESS OF YOUR SURROUNDINGS

Know the types of vegetation that grow on surrounding land. Be aware of the potential behaviour of a fire in this vegetation and the threats it can present under different conditions.

Relevant information is included in **Appendix 5**.

Knowledge and current environment awareness is a valuable source of information that will assist with decision making. Stay alert to current and immediate past weather conditions (hot/dry presenting the worst conditions). Lookout for any evidence of fire (smoke) within your surrounding landscape, for as far as you can see. Be aware of the current and forecast wind direction as any fire will be likely to spread in the direction to which the wind is blowing.

SOURCE	INFORMATION	CONTACT
Emergency WA	Alerts & Warnings. Incidents, fire danger ratings, total fire bans, prescribed burns, preparation, and recovery information.	Website: emergency.wa.gov.au
Department of Fire & Emergency Services	General public emergency information.	Information Line: 13 3337 (13 DFES)  dfes_wa  dfeswa Website (during a bushfire): dfes.wa.gov.au/hazard-information/bushfire/during Website (recovering from a bushfire): dfes.wa.gov.au/hazard-information/bushfire/recovery
Local Radio	Bushfire alerts, warnings, and information.	Local Radio Stations: ABC (AM) 1044 Website: abc.net.au/radio/stations
Emergency Alert on Phone	Voice messages (landline) and text messages (mobile) can be sent within a defined area under an immediate threat.	An automated government telephone warning system.
Bushfire.IO	Map based bushfire warnings, bushfire incidents and wind forecasts. Good visual tool run privately – crosscheck with other sources.	Website: bushfire.io
Bureau of Meteorology	Current / forecast fire weather and fire danger ratings.	Website: bom.gov.au/wa/index.shtml
Parks and Wildlife Service	Bushfire alerts and warnings, prescribed burns in national parks.	Website: dpaw.wa.gov.au
Main Roads WA	Incidents, issues and roadworks.	13 8138 Website: travelmap.mainroads.wa.gov.au/Home/Map

4. THE BUSHFIRE EMERGENCY PROCEDURES AND ACTIONS

4.1. PREVENT AND PREPARE PROCEDURES – NO BUSHFIRE EXISTS

5.1.1 PRE-SEASON PREPARE

PRE-SEASON PREPARE PROCEDURE - REQUIRED ACTIONS

TO BE CONDUCTED PRIOR TO THE BUSHFIRE SEASON WHICH EXTENDS FROM OCTOBER TO APRIL

1. ANNUAL REVIEW OF THE BUSHFIRE EMERGENCY PLAN

Update and amend the Bushfire Emergency Plan as required. Assistance from a bushfire consultant is advised.	
<input type="checkbox"/>	Make required changes to emergency contacts and emergency information sources. Ensure that any changes are also applied to the bushfire emergency information displayed within the facility/premises.
<input type="checkbox"/>	Ensure the designated assembly area, off-site safer locations and nominated evacuation routes are still the best options. Otherwise incorporate the changes into the Bushfire Emergency Plan and associated displayed information.
<input type="checkbox"/>	Where an offsite safer destination is an identified building(s), contact relevant persons to confirm continued availability for potential use during a bushfire emergency.
<input type="checkbox"/>	Account for any change to buildings or equipment onsite that has implications for emergency management.
<input type="checkbox"/>	Incorporate any improvements or additions to the emergency management procedures/actions that have been identified by staff, emergency services because of either experience with a bushfire event or changes in best practice bushfire emergency management that are developed over time.
<input type="checkbox"/>	In the event any part of this BEP is amended as part of its annual review, replace old copies and destroy them.

2. AVAILABILITY & DISPLAY OF BUSHFIRE EMERGENCY INFORMATION

Bushfire Emergency Information is to be available and displayed in prominent position/s and readily accessible to all persons.	
<input type="checkbox"/>	<p>Ensure the display poster 'Bushfire Emergency Information' (updated as necessary) is displayed (framed or laminated) within the premises.</p> <p>Additional information can be displayed when considered appropriate. Examples are contained within the appendices. Copies of these resources are available for download on the DFES website.</p>
<input type="checkbox"/>	Ensure bushfire water supply, bushfire emergency assembly area, evacuation route indicators all emergency signage is in place and legible).

3. BUILDING PREPARATION

<p>These actions address the required maintenance of the buildings that comprise the facility/premises, prior to and during the bushfire season to ensure:</p> <ul style="list-style-type: none"> Continued compliance with the construction standards that correspond to its Bushfire Attack Level (as determined in the Bushfire Management Plan); The vulnerability of exposed building elements and associated items are minimised; and That any installed firefighting infrastructure is operationally ready. 	
<input type="checkbox"/>	<p>If the facility/premises is constructed to BAL-12.5 requirements or higher, ensure any external gaps continue to be blocked or screened with non-combustible material (e.g. rock wool, sealant, mesh – maximum aperture of 2mm) to prevent ember entry. This includes under eaves, external cladding, roofs, external vents, skylights etc. Otherwise it is recommended that this action is applied.</p>
<input type="checkbox"/>	<p>Check that all required window and door screening is in place (prevents ember entry to internal spaces and reduces radiant heat load).</p>
<input type="checkbox"/>	<p>If installed, ensure all installed bushfire shutters are operational.</p>
<input type="checkbox"/>	<p>Where additional construction of attached structures (decks, stairs, patio, carport etc.) or adjacent structures (dwelling, shed, carport etc.) have been built, ensure bushfire resistant (including non-combustible) materials have been used to the greatest extent possible (at least corresponding to construction standards for the BAL rating).</p>
<input type="checkbox"/>	<p>If evaporative air coolers are installed ensure it is either constructed to a BAL rating or is fitted with an appropriate ember protection screen.</p>
<input type="checkbox"/>	<p>All gas cylinders to be installed and maintained in accordance with AS 1596. This standard includes requirements for small portable cylinders and larger cylinders used for domestic house supply. These include:</p> <ul style="list-style-type: none"> Safety release valve shall be directed away from the building and persons access/egress routes; Metal piping and fittings shall be used on all piping inside the building's cavities and enclosable occupied spaces and the high pressure side of any gas regulators; and Tethers securing cylinders are to be non-combustible. <p>The objective is to reduce the risk of local fire against a building and reduce the risk of death or injury, from gas flaring or explosion. The rationale is gas cylinders which have either flared or ruptured are commonly found in post bushfire surveys. The heat from the bushfire or consequential local fire has been sufficient to cause their pressure to reach critical levels beyond which their pressure release valve releases large quantities of LP gas. If these gas cylinders fall over, this pressure release valve may no longer function correctly, meaning that the gas cylinder may continue to increase in pressure with continued heating until the cylinder ruptures. The resulting explosion includes a pressure wave and large ball of flame which can threaten nearby life and buildings.</p>
<input type="checkbox"/>	<p>Around building(s), including verandahs and decks, remove or relocate away from the facility/premises those combustible items that may be seldom used or able to be stored more appropriately in the bushfire season. This includes furniture and mats. Refer to Action List No. 5 'LANDSCAPING DESIGN & CONSTRUCTION PRINCIPLES TO APPLY' for further information regarding consequential fire fuels and recommended separation distances.</p>
<input type="checkbox"/>	<p>Ensure all emergency lighting including pathway lighting and signage lighting is fully functional.</p>

4. GROUNDS PREPARATION

<p>These actions address the required management of onsite combustible items/materials (fuels) around, on or in buildings. By removing or reducing fuels, the likelihood and intensity of consequential fire is significantly reduced. Fuel management must be completed prior to the start of the bushfire season and maintained during the season.</p> <p>For additional guidance, refer to:</p> <ul style="list-style-type: none"> • The <i>Guidelines for Planning in Bushfire Prone Areas within the Explanatory Notes for Element 2 of the Bushfire Protection Criteria and Schedule 1: Standards for Asset Protection Zones (WAPC 2021)</i>; • The DFES 'Bushfire Preparation Toolkit' publication. Website: publications.dfes.wa.gov.au/?hazard=Bushfire; and • Where initial or renovation landscaping of grounds surrounding the facility/premises is being conducted, apply the directions and principles of the measures presented in Appendix 6 to the greatest extent possible. 	
<input type="checkbox"/>	<p>The Firebreak Notice: Maintain compliance with the local government's annual firebreak and fuel load notice issued under section 33 of the Bush Fires Act 1954. Where the requirements are additional to or provide a greater level of bushfire protection than those established in this Emergency Plan, they must be complied with.</p>
<input type="checkbox"/>	<p>Accessibility:</p> <p>Ensure all property access/egress routes are kept clear and easily trafficable.</p>
<input type="checkbox"/>	<p>The Asset Protection Zone(s) (APZ) Dimensions:</p> <p>Ensure the APZ dimensions established by the BMP are installed and maintained to the required standard (as established by the Bushfire Management Plan), and including the requirements in this action list:</p> <ul style="list-style-type: none"> • The Shire of Nannup requires a 20m APZ around buildings.
<input type="checkbox"/>	<p>Vegetation in the APZ – trimming and removal of accumulated debris:</p> <p>Trees (greater than 6 metres in height):</p> <ul style="list-style-type: none"> • Remove branches overhanging buildings and powerlines; • Remove lower branches to a height of 2m above the ground or any surface vegetation; and • Remove loose bark (rake) to at least a height of 2m above the ground or any surface vegetation. <p>Shrubs (0.5 metres to 5 metres in height) and ground covers (greater than 0.5 metres in height):</p> <ul style="list-style-type: none"> • Ensure location and clump sizes remain in accordance with guidance in Action List No. 6; and • Remove all dead plant material. <p>Grass to be reduced and maintained at a height of 50 mm.</p> <p>Fine Fuels (i.e., less than 6 mm in thickness):</p> <ul style="list-style-type: none"> • Ensure combustible dead vegetation matter is reduced to and maintained at less than 2 t/ha on average. Collecting and weighing an indicative 1m² of this litter above the mineral earth will indicate the fuel load (100g/m² = 1 t/ha); and • Remove all debris piles. <p>Heavy Fuels (i.e., greater than 6 mm in thickness):</p> <ul style="list-style-type: none"> • Such as fallen branches, timber, firewood, packaging materials, building materials, outdoor furniture, garbage bins, debris piles. • To be removed from the APZ or be separated from buildings/structures in accordance with guidance in

	<p>Action List No. 6.</p> <p>Applied mulches:</p> <ul style="list-style-type: none"> • Should be non-combustible e.g., stone, gravel and crushed rock. Where wood mulch is used it should be greater than 6mm in thickness.
<input type="checkbox"/>	<p>Buildings and Removal of Accumulated Debris:</p> <p>Remove and maintain at low levels, accumulated vegetation debris (fine fuels) in proximity to buildings and structures, including:</p> <ul style="list-style-type: none"> • In construction crevices, gaps, on horizontal / shallow angle surfaces and at re-entrant corners in access ways, at wall/floor, wall/ground, roof/wall junctions and around doors, vents, windows; • In roof gutters and valleys; and • Adjoining/adjacent drains, culverts and pits.

4.1.2 MAINTENANCE

MAINTENANCE PROCEDURE - REQUIRED ACTIONS

TO BE CONDUCTED DURING THE BUSHFIRE SEASON WHICH EXTENDS FROM OCTOBER TO APRIL

1. MAINTAIN BUILDINGS

<input type="checkbox"/>	Around building(s), including verandahs and decks, remove or relocate away from the facility/premises those combustible items that may be seldom used or able to be stored more appropriately in the bushfire season. This includes furniture and mats. Refer to Action List No. 5 'LANDSCAPING DESIGN & CONSTRUCTION PRINCIPLES TO APPLY' for further information regarding consequential fire fuels and recommended separation distances.
<input type="checkbox"/>	Refer to the 'Action List No. 3 in the 'Pre-Season Prepare' procedure to identify any actions that may not have been conducted or completed and ensure they are actioned.

2. MAINTAIN ASSET PROTECTION ZONES

<p>Maintain Asset Protection Zones (APZ) around all buildings in accordance with the associated Bushfire Management Plan (BMP) which establishes the dimensions of the APZ for the relevant buildings on this site. Refer to the 'Action List No. 4 in the 'Pre-Season Prepare' procedure for dimension details.</p> <p>The required actions remove/reduce accumulated onsite vegetative materials (fuel) and other fuels, thereby reducing the likelihood and intensity of consequential (local) fire which is the most significant cause of building/structure damage/loss in bushfire events.</p>	
<input type="checkbox"/>	Remove all accumulated vegetation debris from the land surface within the APZ, including any stored piles of debris.
<input type="checkbox"/>	Remove all accumulated vegetation debris from on, in and against buildings/structures.
<input type="checkbox"/>	<p>Ensure heavy consequential fire fuels (i.e., greater than 6 mm in thickness) are removed from the APZ or are separated from buildings/structures in accordance with guidance in 'Action List No. 5 in the 'Pre-Season Prepare' procedure.</p> <p>These fuels include fallen branches, timber, firewood, packaging materials, building materials, outdoor furniture, garbage bins etc.</p>
<input type="checkbox"/>	Refer to the 'Action List No. 4 in the 'Pre-Season Prepare' procedure to identify any actions that may not have been conducted or completed and ensure they are actioned.

4.2. RESPONSE PROCEDURES – BUSHFIRE EXISTS

A premises that has no personnel onsite who have formal emergency management responsibilities, is considered an unsupervised premises.

Consequently, the required response actions are simplified, and all necessary information is presented as the Bushfire Information Poster (following page).

On days of Extreme or Catastrophic fire danger, or if there is a fire in the vicinity, guests must depart for a place of safer refuge for the day or until it is safe to return.

This poster must be displayed within the premises.

Emergency Response - Triggers

TRIGGER	PROCEDURE TO BE INITIATED	
	Safe (early) Evacuation	Shelter-in-Place
	PRIMARY	SECONDARY
<p>A BUSHFIRE IS IDENTIFIED – An Alert has been Issued. Listen to the Local Radio (ABC - 684 AM). Monitor your information Sources. A bushfire 'EMERGENCY', 'WATCH AND ACT' or 'ADVICE' warning is in place for the area. Early evacuation should almost always be the Primary action – you should never 'wait and see what happens'. Sheltering-in-place during a bushfire should be a last option when there is insufficient time to evacuate.</p> <p>AN EXTREME OR CATASTROPHIC FIRE DANGER DAY IS FORECAST. Guests staying or arriving must be advised that they must not be at the property during the day. It is the responsibility of the Property owner to ensure that guests are notified of this.</p>	<p>✓</p>	<p>Immediately contact the DFES (000) if you are considering this option. In some limited circumstances such as in remote locations or facilities with people with mobility issues, early evacuation may be difficult to implement, and sheltering-in-place may be the safest action.</p>
<p>A BUSHFIRE IS IDENTIFIED – No Warnings in Place. You are Concerned for your safety. Listen to the Local Radio (ABC - 684 AM). Monitor your information Sources. Early evacuation should almost always be the Primary action – you should never 'wait and see what happens'. Sheltering-in-place during a bushfire should be a last option when there is insufficient time to evacuate.</p>	<p>✓</p>	<p>Immediately contact the DFES (000) if you are considering this option. In some limited circumstances such as in remote locations or facilities with people with mobility issues, early evacuation may be difficult to implement, and sheltering-in-place may be the safest action.</p>

BUSHFIRE EMERGENCY INFORMATION

314 Chalwell Road, Carlotta

THE PRIMARY EMERGENCY PROCEDURE TO FOLLOW FOR THIS PREMISES IS SAFE (EARLY) EVACUATION

Trigger to Evacuate: A bushfire is identified relatively close, and a bushfire EMERGENCY or WATCH AND ACT warning may or may not be issued., You are concerned for your safety.

Procedure: Call 000 to report bushfire if no warnings current. Cease all activities, shut all doors/windows, turn off air conditioners, turn off bottled gas and move to assembly area designated on the adjacent map. Prepare vehicles. Check information sources for latest updates, dial 000 if unsure. Re-evaluate the situation to ensure evacuation routes remain available (if not, follow shelter in place procedure below). Follow emergency services instructions if they are present.

ELEVATED THREAT PROCEDURE

Trigger to Act: A bushfire is identified a considerable distance away, and a bushfire ADVICE warning may or may not be issued but you are concerned for your safety.

Procedure: Call 000 to report bushfire if no warnings current. Ensure everyone at the premises is aware of the situation, closely monitor the information sources and the changes outside. If the current Fire Danger Rating is Catastrophic or Extreme or persons have health conditions, consider pre-emptively leaving the accommodation and travel to a lower threat area for the day.

SHELTER-IN-PLACE PROCEDURE

Trigger to Shelter: Impact from bushfire is imminent, evacuation routes are threatened and there is no time to perform a safe (early) evacuation or emergency services have instructed you to shelter in place.

Procedure: Call 000 to report the bushfire and tell them you are sheltering in place. Shut all doors/windows, turn off air conditioners, turn off bottled gas, move all combustible materials away from windows, wet materials to block gaps around door. Drink plenty of water, stay aware of what is happening, and monitor information sources.

The detailed emergency management procedures for this premises are established in the Bushfire Emergency Plan located in the Guest compendium with the provided Guest Information.

FORECAST FIRE DANGER RATINGS

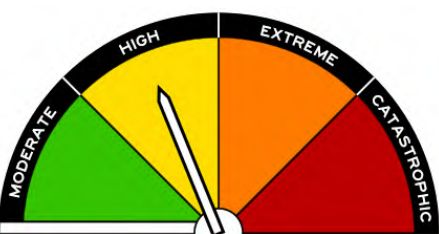

The higher the rating, the more dangerous the conditions and the greater the consequences if a fire starts.

No Rating	No Action Required
Moderate	Plan and Prepare
High	Be Ready to Act
Extreme	Take Action Now to Protect Your Life and Property
Catastrophic	For Your Survival, Leave Bush Fire Risk Areas

BUSHFIRE EVENT WARNINGS

	ADVICE A fire has started but there is no immediate threat to lives or homes. Be aware and keep up to date.
	WATCH AND ACT There is a possible threat to lives or homes. You need to leave or get ready to defend – do not wait and see.
	EMERGENCY WARNING There is a threat to lives or homes. You are in danger and need to take immediate action to survive.

000
Fire or Life Threatening
Emergencies



Alerts and Warnings
emergency.wa.gov.au

13 3337
DFES Emergency
Information

132 500
SES Emergence
Assistance

13 13 51
Western Power

@dfeswa
DFES Facebook



Property Owner: 0427 703 490

Nannup Hospital (08) 9756 3800

Manjimup Hospital (08) 9772 5100

Evacuation Route 1. Nannup Recreation Centre.

Depart property to left on Chalwell Road. Turn right onto Vasse Highway 8.7kms. Turn right onto Brockman Hwy 1.4kms and turn left into Centenary Avenue. The Recreation Centre will be on your right.

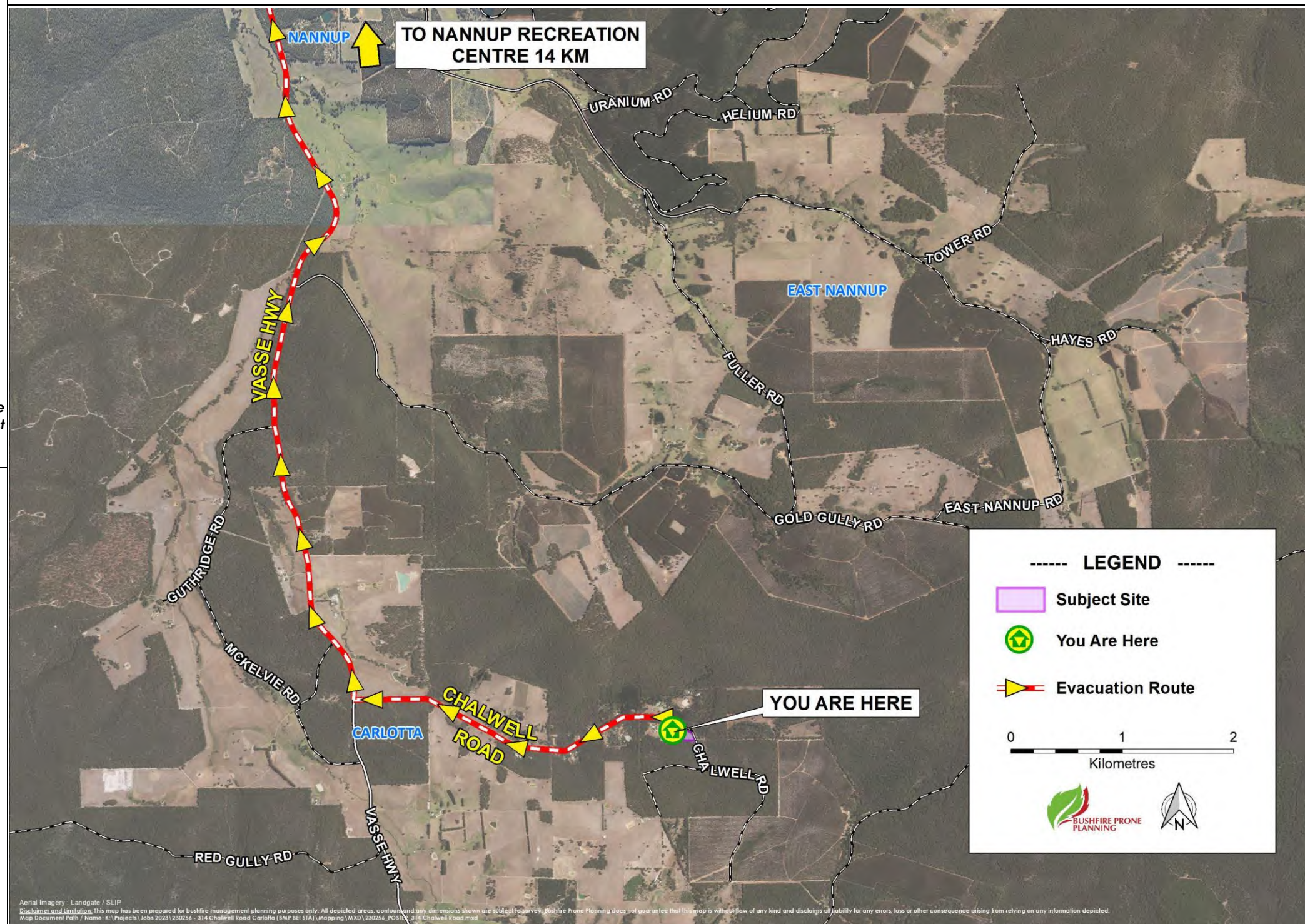

Aerial Imagery: Landgate / SLIP
Disclaimer and Limitation: This map has been prepared for bushfire management planning purposes only. All depicted areas, contours and any dimensions shown are to the best of our knowledge. Bushfire Prone Planning does not guarantee that this map is without error of any kind and disclaims all liability for any errors, loss or other consequence arising from relying on any information depicted.
Map Document Path / Name: K:\Projects\Jobs\2023\230254 - 314 Chalwell Road Carlotta (BMP 881 STA)\Mapping\MXD\230254_POSTED_314 Chalwell Road.mxd

5.1. THE SAFE (EARLY) EVACUATION PROCEDURE

- A. An 'Advice,' 'Watch and Act' or 'Emergency Warning' alert has been issued by an emergency service authority.**
- B. A Bushfire has been identified near your location. You are concerned for your safety.**
- C. An Extreme or Catastrophic fire danger day is forecast.**

Refer to the BUSHFIRE EMERGENCY INFORMATION Poster

1. Monitor the **ABC local radio (Busselton - 684 AM)** and other information sources regularly for local bushfire information (weather trends, warnings, locations).
2. Call 000 if you are concerned for your safety.
3. Evaluate if the evacuation routes remain available.
4. Occupants must identify the appropriate evacuation route to use.
5. Be aware of your ongoing ability to evacuate safely and base the decision to evacuate on this ability or any emergency services directives received.
6. Take with you any medications you may require if there is a road closure and you can't return promptly.

If the Evacuation Routes are determined to no longer be safe, then SHELTERING-IN-PLACE will be the required action.

Shelter in the Dwelling (Last Resort)

Note: *Sheltering in the existing dwelling differs vastly from a Refuge Building or Refuge Open space. Early evacuation before a bushfire starts should always be the priority.*

Immediately notify DFES by dialling 000 and give the following details:

1. Nature of the incident and state that people are sheltering in place;
2. Location (street address);
3. Nearest cross roads (names and distance);
4. Where sheltering;
5. Number of people sheltering;
6. Can you see the fire front /estimate distance away; and
7. Can you see spot fires / are spot fires around the shelter?

If the nominated Emergency Assembly Building is deemed unsafe or to be under direct threat, occupants must evaluate the situation and make informed decisions. The choice will be to continue to stay and defend or proceed to an area of minimal fuel vegetation as a last resort and if it is safe to do so. The latter action is not recommended but is an alternative if the current refuge is deemed to be not safe for occupants and vehicle evacuation routes remain unsafe.

APPENDIX 1: BUSHFIRE WARNINGS – WHEN A BUSHFIRE IS IDENTIFIED



EMERGENCY WARNING

An out of control fire is approaching fast and you need to take immediate action to survive. If you haven't prepared your home it is too late.

You must seek shelter or leave now if it is safe to do so.



WATCH AND ACT

A fire is approaching and there is a possible threat to lives or homes. Put your plan into action. If your plan is to leave, make sure you leave early. If your plan is to stay, check all your equipment is ready.

Only stay and defend if you are mentally and physically prepared.



ADVICE

A fire has started but there is no immediate danger. Stay alert and watch for signs of a fire.

Be aware and keep up to date.

Where can I get information during an emergency?

emergency.wa.gov.au 13 DFES (13 33 37)

@dfeswa @dfes_wa Local ABC Radio



APPENDIX 2: FIRE DANGER RATINGS - FORECAST BUSHFIRE RISK

THE HIGHER THE RATING, THE MORE DANGEROUS THE CONDITIONS AND THE GREATER THE CONSEQUENCES IF A FIRE STARTS.



Moderate: Plan and prepare.

Most fires can be controlled. Stay up to date and be alert for fires in your area.

High: Be ready to act.

Fires can be dangerous. Decide what you will do if a fire starts. Leave bushfire risk areas if necessary.

Extreme: Take action now to protect your life and property.

Fires will spread quickly and be extremely dangerous. Put your bushfire plan into action. If you and your property are not prepared to the highest level, plan to leave early.

Catastrophic: For your survival, leave bushfire risk areas.

These are the most dangerous conditions for a fire. If a fire starts and takes hold, lives are likely to be lost. Homes cannot withstand fires in these conditions.



When there is minimal risk, Fire Danger Ratings will be set to 'No Rating'. On these days you still need to remain alert and abide by local seasonal laws and regulations.



Monitor conditions and [emergency.wa.gov.au](https://www.emergency.wa.gov.au) for ratings and bushfire warnings. If a fire starts near you, take action immediately to protect your life. Do not wait for a warning.



Your life may depend on the decisions you make, even before there is a fire. Create or review your bushfire plan at mybushfireplan.wa.gov.au



This publication is intended to be a guide only. While every effort is made to ensure accuracy at the time of publication, DFES makes no representation about the content or suitability of the information provided. DFES expressly disclaims liability for any loss or omission done or not done in the reliance on the information and for any consequences whether direct or indirect, arising from such loss or omission.

JUNE 2022/V1.0



APPENDIX 3: BUSHFIRE RISKS AND DANGERS



BUSHFIRE RISKS AND DANGERS



BUSHFIRES HAPPEN EVERY SUMMER; THEY CAN START SUDDENLY AND WITHOUT WARNING.
If you live in or near bushland you need to understand the risks and dangers that bushfires cause. Remember that flames are not the only risk you face in a bushfire.



EMBER ATTACK

Ember attack occurs before, during and after a fire front passes.

Embers are pieces of burning bark, leaves or twigs that are carried by the wind around the main fire creating spot fires.

Spotting can be carried over half a kilometre from a fire.

Embers can land in areas around your home such as your garden, under or in the gutters of your home and on wooden decks.

If not extinguished, your house could catch fire.

RADIANT HEAT

The hotter, drier and windier the day, the more intense a bushfire will be and the more radiant heat it will generate.

Radiant heat can cause injury and death from burns and cause the body's cooling system to fail, leading to heat exhaustion and possible heart failure.

It is important that you include water and appropriate clothing in your emergency kit and consider where you will shelter during a bushfire to protect yourself from radiant heat.

SMOKE

Lung injuries and suffocation can occur where the body is exposed to smoke and super-heated air.

It is important to seek shelter when heat and smoke are most intense.

Your nose and mouth should be covered with a dust mask, wet towel or scarf.

A special filter mask should be included in your survival kit for people in your family who suffer respiratory conditions such as asthma.



For more information visit dfes.wa.gov.au/bushfire
or contact DFES Community Preparedness: Community.Preparedness@dfes.wa.gov.au
or **9395 9816**

The information contained in this material is provided voluntarily as a public service by the Department of Fire and Emergency Services (DFES). This material has been prepared in good faith and is derived from sources believed to be reliable and accurate at the time of publication. Nevertheless, the reliability and accuracy of the information cannot be guaranteed and DFES expressly disclaims liability for any act or omission done or not done in reliance on the information and for any consequences whether direct or indirect, arising from such act or omission. This publication is intended to be a guide only and viewers should obtain their own independent advice and make their own necessary inquiries.



APPENDIX 4: GUIDELINES FOR TRAVELLING IN CARS DURING A BUSHFIRE



TRAVELLING DURING A BUSHFIRE



BUSHFIRES CAN START WITHOUT WARNING. People have been killed or seriously injured during bushfires. If you are travelling or staying near bushland, fire is a real risk to you. **Pack an emergency kit including important items such as woollen blankets, drinking water and protective clothing.**



IF THERE IS A LOT OF SMOKE

- Slow down as there could be people, vehicles and livestock on the road.
- Turn your car headlights and hazard lights on.
- Close the windows and outside vents.
- If you can't see clearly, pull over and wait until the smoke clears.

IF YOU BECOME TRAPPED BY A FIRE

- Sheltering inside a vehicle is a very high risk strategy. It is unlikely that a person will survive in all but the mildest circumstances.**
- Park the vehicle off the roadway where there is little vegetation, with the vehicle facing towards the oncoming fire front.
- Turn the engine off.
- Close the car doors, windows and outside vents, **and call 000.**
- Stay in the car until the fire front has passed. Stay as close to the floor as possible and cover your mouth with a damp cloth to avoid inhalation of smoke.
- Stay covered in woollen blankets, continue to drink water and wait for assistance.
- Once the front has passed and the temperature has dropped, cautiously exit the vehicle.

IMPORTANT INFORMATION

- Find the local ABC radio frequency in the area. Stay up to date in a major emergency, when lives and property are at risk, ABC radio will issue broadcast warnings at a quarter to and a quarter past the hour.
- Main Roads provides updated information on road closures throughout WA. Call 138 138 or www.mainroads.wa.gov.au
- Check the weather forecast and current fire restrictions. Be aware of the Fire Danger Rating for the area you are travelling to and be prepared to reassess your plans.
- Download the Bushfire Traveller's Checklist at www.dfes.wa.gov.au

For more information visit dfes.wa.gov.au/bushfire

or contact DFES Community Preparedness: Community.Preparedness@dfes.wa.gov.au or **9395 9816**



The information contained in this material is provided voluntarily as a public service by the Department of Fire and Emergency Services (DFES). This material has been prepared in good faith and is derived from sources believed to be reliable and accurate at the time of publication. Nevertheless, the reliability and accuracy of the information cannot be guaranteed and DFES expressly disclaims liability for any act or omission done or not done in the reliance on the information and for any consequences whether direct or indirect, arising from such act or omission. This publication is intended to be a guide only and viewers should obtain their own independent advice and make their own necessary inquiries.



APPENDIX 5: INDICATIVE BUSHFIRE BEHAVIOUR TO IMPACT THE FACILITY/PREMISES

Information Relevance: This information is included in the Bushfire Emergency Plan to inform and assist the decision making of those persons onsite who have the responsibility to manage a bushfire emergency for the subject facility/premises.

The information establishes the key factors to be considered in understanding the types and scale of key bushfire behaviours that can be expected to impact the facility/premises on a given day. These factors are the type of vegetation that exists on the land surrounding the subject premises/facility, the relevant surrounding terrain, and the forecast Fire Danger Rating (FDR) that applies to the locality.

Information Source: The information is taken from the bushfire behaviour modelling applied within the **Australian Fire Danger Rating System (AFDRS)**. Within this system, eight accepted bushfire behaviour models, describing mathematically the way fire moves and spreads through different vegetation types, are currently available and are applied to twenty two different vegetation types across Australia.

The modelling is used to derive the Fire Behaviour Index (FBI) that assists firefighting operational decision making. From the FBI, Fire Danger Ratings (FDR) are derived which provide the broad categories needed to communicate fire danger to the community. The determination of the daily FDR considers the vegetation types present and the forecast fire weather conditions. The higher the rating, the more dangerous the conditions and the greater the consequences if a fire starts. (Source: AFDRS project led by NSW RFS, Australian Bureau of Meteorology and AFAC).

The Fire Behaviour Triangle

The behaviour of a bushfire, including the types of threats, intensity and how quickly it moves, depends on the three factors of vegetation, weather and terrain.

This is known as the fire behaviour triangle – because all three factors combine to shape the characteristics of the bushfire (source: CSIRO ‘Bushfire best practice guide’ at ... research.csiro.au/bushfire/).

The influence of fire weather (FDR) and vegetation types (as per AFDRS) on the potential bushfire impact to the subject facility/premises, can be derived from the tables presented on the following page(s). Greater fuel loads will result in behaviours at the higher end of stated values.

The influence of terrain can be derived by considering the existence and degree of sloping ground and changes in changes in relief (e.g., flat, undulating or rugged land), surrounding the subject facility/premises and particularly under the vegetation.

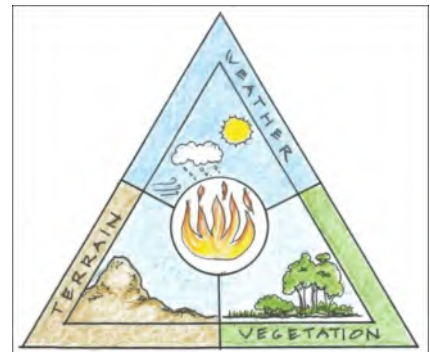

The Influence of Terrain (topography)

A fire will burn faster uphill. This is because the flames can easily reach more unburnt fuel in front of the fire. Radiant heat pre-heats the fuel in front of the fire, making the fuel even more flammable.

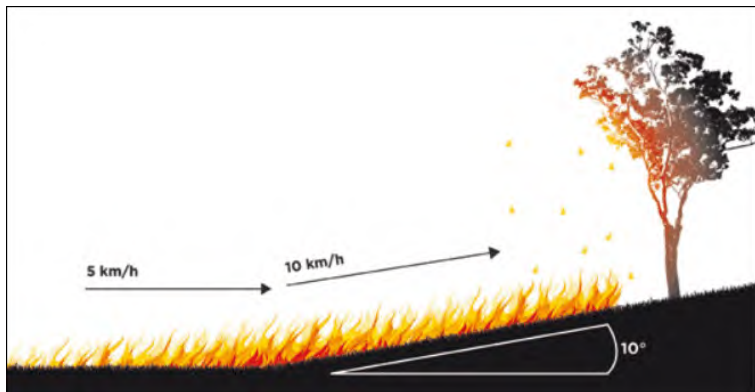

(source: Country Fire Authority, Victoria).

For every 10° slope, the fire will double its speed. For example, if a fire is travelling at 5 km per hour along flat ground and it hits a 10° slope it will double in speed to 10 km per hour up the hill. By increasing in speed the fire also increases in intensity, becoming even hotter.

The opposite applies to a fire travelling downhill. The flames reach less fuel, and less radiant heat pre-heats the fuel in front of the fire. For every 10° of downhill slope, the fire will halve its speed. Fires tend to move more slowly as the slope decreases

Terrain should be considered for its potential to increase adverse fire behaviour including flame heights, forward rates of spread and ember production (in relevant vegetation i.e., primarily bark fuels). Essentially, where vegetation exists on sloping land near your site, assume that the higher end of adverse fire behaviours is much more likely to apply.

VEGETATION TYPES IDENTIFIED SURROUNDING THE SUBJECT FACILITY/PREMISES		
As Applied in the AFDRS		Vegetation Location Relative to the Facility/Premises
Fire Behaviour Model (short name)	Fuel Types / Description	
Forest	Dry eucalypt forests, shrubby understorey/litter surface fuel. Forests with high moisture content due to structure, topography or inundation.	Forest vegetation located to the north, west and south of the property.
Grassy Woodland (Savanna)	Woodland and shrubland with a continuous grass understorey. Arid woodland/shrubland with short lasting (seasonal) grass understorey. Perennial woody horticulture with grass understorey (orchard/vineyard). Rural/Urban residential areas of grass with variable tree cover.	
Shrubland	Temperate shrublands and heathlands of varying heights. Includes wet heathlands.	
Grassland	Continuous/tussock grasslands. Modified/native pasture (grazing). Non-irrigated cropping. Low shrublands (wet or arid) with no overstorey.	Vegetation located directly to the north of the buildings
Mallee-Heath	Semi-arid woodland and shrubland with shrub understorey.	
Spinifex	Woodland and shrubland with a hummock grass understorey. Includes mallee if spinifex understorey.	
Pine	Pine plantations	

FOREST

THE INDICATIVE FIRE BEHAVIOUR CORRESPONDING TO THE FIRE BEHAVIOUR INDEX (0-100) AND THE ASSOCIATED FIRE DANGER RATING (FDR)

Source: AFDRS v. 2022_6

FDR	INDICATIVE BUSHFIRE BEHAVIOUR		
NO RATING	<p>MAX FLAME HEIGHT <1 m</p> <p>0-5</p> <p>RATE OF SPREAD 0-40 m/hr</p>	<p>Fire difficult to ignite and sustain. Fires generally unlikely to spread and likely to self-extinguish.</p>	<p>SPOTTING POTENTIAL Potential for any spotting is very limited and likely <150 m</p>
	<p><4 m</p> <p>6-11</p> <p>20-110 m/hr</p>	<p>Slow spreading fires, typically involving surface and near-surface fuels and sometimes bark and elevated fuels. Spotting is sporadic and limited to short-distances.</p>	<p>Potential for spotting is limited with short distance spotting possible up to 400 m</p>
MODERATE	<p>2-8 m</p> <p>12-23</p> <p>60-600 m/hr</p>	<p>Actively spreading fires typically involving surface, near-surface, elevated and bark fuel layers and occasionally canopy fuels. Low-moderate spotting frequency; isolated medium range spotting can occur.</p>	<p>Short distance spotting occurring with increasing frequency with possible medium distance spotting up to 2 km</p>
HIGH	<p>7-14 m</p> <p>24-49</p> <p>0.3-1 km/hr</p>	<p>Rapidly spreading fires with potential for development into large burn areas within burning period. Fires typically involving most fuel layers. Short-range spotting is prevalent, with possibility of medium range and occasional long-range distance spotting.</p>	<p>Short and medium distance spotting occurring with increasing frequency with possible long distance spotting up to 4 km</p>
EXTREME	<p>11 m - approx. double forest</p> <p>50-99</p> <p>0.7-3 km/hr</p>	<p>Fires likely to quickly transition to crowning. Possibility for fire behaviour to become erratic and plume driven. Strong convective column formation. Wind speed and direction likely to be erratic at times.</p>	<p>High ember density in short and medium range with possible long distance spotting up to 12 km</p>
CATASTROPHIC	<p>>30 m (approx. double forest height)</p> <p>100+</p> <p>>2 km/hr can be expected, possibly >3 km/hr</p>	<p>Fires likely to quickly transition to crowning. Possibility for fire behaviour to become erratic and plume driven. Strong convective column formation. Wind speed and direction likely to be erratic at times.</p>	<p>High ember density in short and medium range with possible long distance spotting occurring 20-30 km ahead of the main fire front</p>

GRASSLAND

THE INDICATIVE FIRE BEHAVIOUR CORRESPONDING TO THE FIRE BEHAVIOUR INDEX (0-100) AND THE ASSOCIATED FIRE DANGER RATING (FDR)

Source: AFDRS v. 2022_6

FDR	INDICATIVE BUSHFIRE BEHAVIOUR				
NO RATING	<p>MAX FLAME HEIGHT <1 m</p>	<p>0-5</p>	<p>RATE OF SPREAD 0-30 m/hr</p>	<p>Fire difficult to ignite and sustain. Fires generally unlikely to spread and likely to self-extinguish.</p>	<p>SPOTTING POTENTIAL Potential for any spotting is very limited.</p>
	<p><1.5 m</p>	<p>6-11</p>	<p><13 km/hr</p>	<p>Fire easily sustained. Typically wind driven fires that can spread quickly.</p>	<p>Potential for spotting Potential for short distance spotting is limited.</p>
MODERATE	<p>1.5-2.5 m</p>	<p>12-23</p>	<p>0.5-6 km/hr</p>	<p>Typically wind driven and rapidly spreading fires with the potential to gain size quickly.</p>	<p>Possible short distance spotting occurring.</p>
HIGH	<p>2-3 m</p>	<p>24-49</p>	<p>2.5-10 km/hr</p>	<p>Wind driven, rapidly spreading fires with potential for development into large fire area/size and with the potential for short distance spotting and long flame lengths.</p>	<p>Short distance spotting occurring with increasing frequency.</p>
EXTREME	<p>2.5-3.5m</p>	<p>50-99</p>	<p>5-16 km/hr</p>	<p>Extremely rapid fire growth and increasing likelihood of large final fire area/size. Possibility for fire behaviour to become erratic and plume driven. Strong convective column formation. Wind speed and direction likely to be erratic at times.</p>	<p>Likely short distance spotting occurring with increasing frequency.</p>
CATASTROPHIC	<p>>3m</p>	<p>100+</p>	<p>>8 km/hr can be expected, possibly >16 km/hr</p>	<p>Extremely rapid fire growth and high likelihood of large final fire area/size. Possibility for fire behaviour to become erratic and plume driven. Strong convective column formation. Wind speed and direction likely to be erratic at times.</p>	<p>Likely short distance spotting occurring with increasing frequency.</p>

APPENDIX 6: LANDSCAPING DESIGN & CONSTRUCTION PRINCIPLES TO APPLY

Where initial or renovation landscaping of grounds surrounding the facility/premises is being conducted, apply the directions and principles of the following measures to the greatest extent possible.

For additional guidance, refer to:

- The *Guidelines for Planning in Bushfire Prone Areas within the Explanatory Notes for Element 2 of the Bushfire Protection Criteria and Schedule 1: Standards for Asset Protection Zones (WAPC 2021)*; and
- The DFES 'Bushfire Preparation Toolkit' publication. Website: publications.dfes.wa.gov.au/?hazard=Bushfire

Use of Non-Vegetated Areas and/or Public Open Space:

Reduce the exposure of the facility/premises to the direct and indirect threats of bushfire by incorporating low threat uses of land adjoining the facility/premises and/or the bushfire hazard. These uses create robust and easier managed asset protection zones and include:

- Non-vegetated areas e.g. footpaths, paved areas, roads, driveways, parking, drainage, swimming pools;
- Formally managed areas of vegetation (public open space and other recreation areas), including irrigated areas; and
- Services installed in a common section of non-vegetated land.

Landscaping – Non-Combustible Construction: Ensure non-combustible materials are used for fencing and any other landscaping construction, including retaining walls.

Landscaping – Tree and Plant Species Selection

Utilise trees and plants with characteristics that are more resistant to burning. Refer to *Guidelines for Planning in Bushfire Prone Areas, Appendix 4 'Explanatory Notes E2: Plant Flammability' (WAPC 2021)* for initial guidance.

Avoid planting trees with ribbon or stringy barks (ember/firebrand production). Preference for smooth bark.

Landscaping – Tree and Plant Separation from the Facility/Premises (Location):

Trees (greater than 6 metres in height: Minimise the potential for tree strike damage (falling or blown) to the facility/premises (allowing flame, radiant heat and ember entry to internal spaces), and debris accumulation on, in and around the facility/premise. Principles to apply are:

- Ideally trees will be separated from buildings/structures by a distance of at least 1.5 times the height of the tallest tree;
- As a minimum, trunks at maturity should be at least 6 metres from all elevations of the building, branches at maturity should not touch or overhang a building or powerlines. Mature tree canopies should be separated at least 5m with total canopy cover not exceeding 15% and not connected to tree canopy outside the APZ;
- Species of trees that produce significant quantities of debris (fine fuels) during the bushfire season should be located a sufficient distance away from vulnerable exposed elements to ensure debris cannot drop and accumulate within at least 4m of buildings/structures or be likely to be relocated by wind to closer than 4m to buildings / structures.

Shrubs and scrub (0.5 metres to 6 metres in height):

- Should not be located under trees or within 3 metres of buildings;
- Should not be planted in clumps greater than 5m² in area;

- Clumps of shrubs should be separated from each other and any exposed window or door by at least 10 metres (unless they can be classified as low flammability plants); and
- Shrubs greater than 6 metres in height are to be treated as trees.

Ground covers (less than 0.5 metres in height):

- Can be planted under trees but and no closer than two metres from a structure but 3 metres from doors or windows if greater than 100 mm in height; and
- Ground covers greater than 0.5 metres in height are to be treated as shrubs.

Grass: Where possible utilise irrigated perennial species.

Mulches should be non-combustible e.g., stone, gravel and crushed rock. Where wood mulch is used it should be greater than 6mm in thickness.

Separation Between the Facility/Premises and the Consequential Fire Fuels of Stored Flammable Products (Fuels / Other Hazardous Materials):

If applicable, establish sufficient separation distance between the consequential fire fuels and the facility/premises. The required separation distance will be dependent on the fuel and storage type and will need to be determined.

Separation Between the Facility/Premises and the Consequential Fire Fuels of Stored and Constructed Combustible Items:

These consequential fire fuels include:

- Stored Combustible Items - Heavy Fuels (greater than 6mm diameter) e.g. building materials, packaging materials, firewood, branches, sporting/playground equipment, outdoor furniture, garbage bins etc:
- Stored Combustible Items – Large Heavy Fuels e.g. vehicles, caravans, boats, trailers and large quantities of dead vegetation materials stored as part of site use.
- Constructed Combustible Items – Heavy Fuels e.g. landscaping structures including fences, screens, walls, plastic water tanks.
- Constructed Combustible Items – Large Heavy Fuels e.g. adjacent buildings/structures including houses, sheds, garages, carports. (Note: If the adjacent structure is constructed to BAL-29 requirements or greater and can implement a significant number of additional bushfire protection measures associated with reducing exposure and vulnerability, these minimum separation distances could be reduced by 30%).

Apply the rule of thumb “assume flames produced from a consequential fire source will be twice as high as the object itself ... where the consequential fire source is a structure, then the maximum eave height is a reasonable measure of maximum height”.

Apply the following separation distances from the subject building/structure as a multiple of the height of the consequential fire source and dependent on the bushfire construction standard applied to the building/structure:

- At least six times the height when the facility/premises construction incorporates design and materials that is only intended to resist low levels of radiant heat up to 12.5 kW/m² and no flame contact (BAL-12.5);
- Between 4 and 6 six times the height when the facility/premises construction incorporates design and materials intended to resist radiant heat up to 29 kW/m² and no flame contact (BAL-29).
- Between 2 and 4 times the height when the facility/premises construction incorporates design and materials intended to resist up to 40kW/m² and potential flame contact (BAL-40).
- Less than 2 times the height when the facility/premises construction incorporates design and materials intended to resist extreme levels of radiant heat and flame contact (BAL-FZ).

- Zero separation distance is required if the facility/premises is separated by a non-combustible FRL 60/60/60 rated wall, or the potential consequential fire source is fully enclosed by the facility/premises.

- Constructed Barriers to Shield Facility/Premises from Bushfire:** Where applicable, install walls, fences and/or landforms to shield the facility/premises (or any identified consequential fire fuels – refer to previous item) from direct and indirect bushfire attack mechanisms and reduce the potential impact of these threats.

These barriers should be constructed using appropriate fire resistant / non-combustible construction materials (e.g. masonry, steel, earthworks). These are to withstand the impact of direct bushfire attack mechanisms for the required period.

- Constructed Barriers to Shield Facility/Premises from Consequential Fire:** Applicable to all identified consequential fire fuel sources. Install a non-combustible barrier (including complete enclosure when appropriate), of required robustness, that will reduce the exposure of the facility/premises to the threats of consequential fire.

- Planted Vegetation Barrier to Shield Facility/Premises:** Use appropriate species (lower flammability) of hedges and trees strategically to reduce the facility/premises exposure to radiant heat, to filter/trap embers and firebrands, and to lower wind speeds (prevailing synoptic and/or fire driven).

- Shield Non-Structural Essential Elements:** These are vulnerable elements essential to the continued operation of the facility/premises which are potentially exposed to the fire attack mechanisms of both bushfire and consequential fire. They include electricity cabling and water plumbing and also applies to any installed firefighting equipment / water storage.

When the use of fire rated materials to the degree necessary is not possible or practical, the application of non-combustible shielding can be applied to reduce exposure to the bushfire threats. Shielding includes underground installation.

- Constructed Barrier to Shield Persons on Pathways to Safer Onsite Area/Building:** Where possible, alongside the relevant pathways, utilise walls / fences / landforms as shielding structures constructed using fire resistant / non-combustible construction materials (e.g. masonry, steel, earthworks).

These are to withstand the impact of direct bushfire attack mechanisms for the required period and provide the required reduction in threat levels to persons (including firefighters) traversing the pathway.